

DAVIS 

ECHOMASTER™ RADAR REFLECTORS

Features, Installation, Design Principles



**R155E
\$1.00**

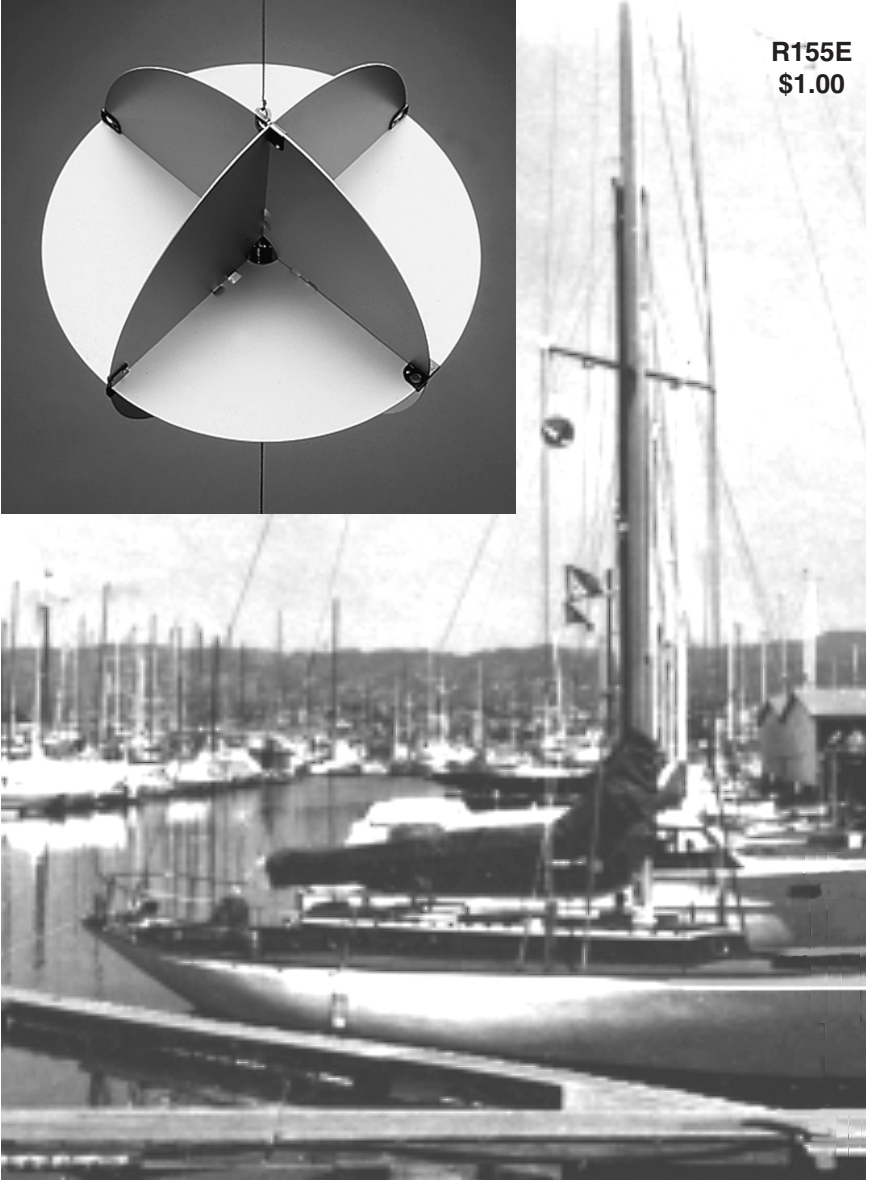

Contents

Why Use a Radar Reflector?	2
Echomaster™ Radar Reflectors	3
How a Ship's Radar Sees Your Boat	4
Echomaster Specifications	4
Radar Reflector Design	6
Reflectivity	7
Radar Frequency	8
Radar Cross Section	8
Plate Design	9
Alignment of Reflector Plates	9
Installing Echomaster	
Positioning the reflector	10
Assembling the reflector plates	11
Mounting Echomaster #152	12
Mounting Echomaster #153	13
Suspending the Echomaster from a spreader	14
Using the #157 Surface Mount System	15
Echomaster Maintenance	16

Why Use a Radar Reflector?

Collision avoidance is surely the most important part of enjoying the boating world. Small and medium-sized boats are surprisingly poor targets for radar reflection and are frequently in danger of being overrun by larger vessels, even under good visibility conditions.

The radar display on a ship will typically show surrounding conditions for at least 12 nautical miles (22 km), with gain and sea clutter controls for adjustment.

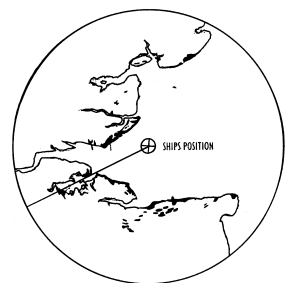
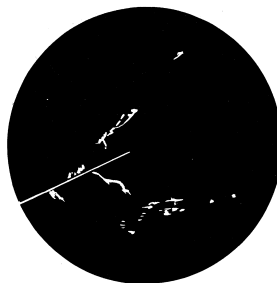

TYPICAL RADAR DISPLAY

But boats of today, with fiberglass hulls and sleek

designs (curved or slanted surfaces reflect much less), do not possess enough reflective qualities to make them highly visible on a radar screen. The response may be small, weak or intermittent. Even a boat's metal mast (a curved surface) and engine (mounted low, in the realm of sea clutter) do not possess enough reflective qualities to make the boat highly visible to radar. And container vessels and tankers require long stopping time and wide turning radius. Ensuring the detectability and recognition of your craft at a long distance from an overtaking vessel under all weather and sea conditions is critical to avoid disaster. Without a radar reflector (or radar of your own) you're left to peer into the fog or darkness or listen for bells,

foghorns, propellers, or the mighty bowwave from an onrushing “skyscraper of steel.” Even if you did spot them or detect them on your radar, which way would you turn? Best to let them “see” you instead.

Furthermore, in distress situations the Coast Guard can be materially aided in search and rescue by the deployment of a good radar reflector. The U.S. Coast Guard is considering marine radar reflector requirements that would apply to pleasure boats operating in waters of the United States. Already such laws exist in many other countries such as the United Kingdom, Canada and Germany.

Radar reflectors may also be mounted on a buoy or piling to help identify your dock or mooring in less than perfect conditions. They can also supplement official markings on hazards to navigation such as bridges, rocks, submerged trees, sunken boats.

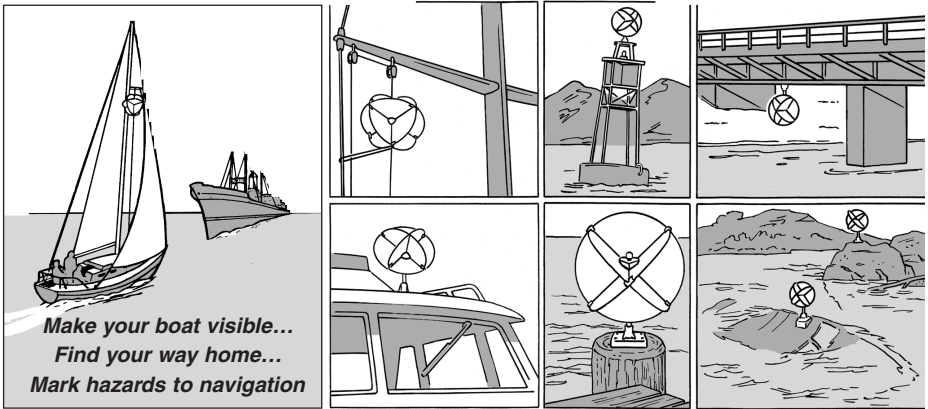

DAVIS

ECHOMASTER™

RADAR REFLECTORS

Echomaster™ radar reflectors give ships a chance to see your boat in fog and low visibility conditions—a must for serious boaters. The Echomaster circular plate radar reflector is the most practical, efficient, and cost-effective reflector available to pleasure boaters.

Echomaster’s superiority is proven. It was ranked one of the world’s best radar reflectors and one of the top ten sailing products by *Practical Sailor*. SRI rated Echomaster “superior” after the most rigorous tests ever conducted on radar reflectors, some costing 10 times as much.



How a Ship's Radar Sees Your Boat

The radar of a ship making a complete circle around a boat would hit the boat's radar reflector from all angles. If the boat were stationary and we plotted how strong the reflected signal is at all angles, we would arrive at **performance diagrams** such as this...

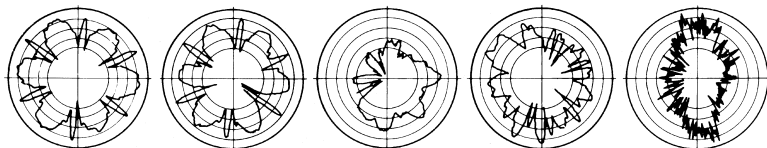

DAVIS
ECHOMASTER
#152, 153

DAVIS
EMERGENCY
RADAR
REFLECTOR
#151

MOBRI RADAR
REFLECTOR

FIRDELL
BLIPPER

RADAR
FLAG

Admiralty surface weapons test, England

The outside of the circle is what a 10^2 meter cross section of a metallic sphere would reflect—the laboratory standard. The larger the performance plot, the better the radar reflector. Peaks in the pattern should approach the laboratory standard and be uniformly distributed 360° around the fixed reference point (your boat). Valleys should be minimal in width. The Davis reflectors show good balance: strong peaks, narrow valleys. Other reflectors have inadequate peaks or large areas of weak response, making them seem smaller on an oncoming ship's radar screen.

Echomaster Specifications

Reflector plates are 12.5" (32 cm) diameter, circular, aluminum. Plates provide 13.2 square yards (12 sq. meters) of maximum effective radar cross section in the X or 3 cm band (9–9.6 GHz frequency), based on optimum orientation between the reflector and radar. Echomaster offers equivalent radar cross section of conventional triangular plate reflector with approximate 17" (43 cm) diagonal dimension.



Plates are made of robust 0.05" (1.3 mm) marine grade aluminum; sufficient thickness to minimize flexing. Dimples in plates allow corner latches to attach precisely, minimizing angular distortion.

Windage holes reduce aerodynamic drag and allow assembly of the reflector around a backstay. Windage hole size 1.25" (32 mm).

Captive corner latches are tough, injection molded plastic to assure minimum angle error. Corner latches allow reflector to be quickly and easily assembled and demounted. Reflector stows flat.

Weight without mounting hardware: 1.65 lbs. (.75 kg). #153 mounting harness weighs 1.5 oz. (.4 kg).

#152 Standard Echomaster

Aluminum plates. May be assembled around a backstay, or make your own bridle and hang from holes drilled in corner latches. #157 Surface Mount System can be purchased separately.

#153 Deluxe Hanging Echomaster

Anodized aluminum plates. Comes with hanging mount system to suspend unit from mast or rigging in perfect "catch rain" position. Vinyl storage case included. #157 Surface Mount System can be purchased separately.

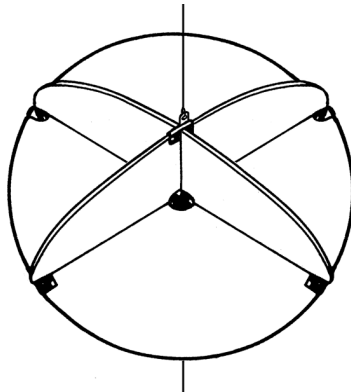
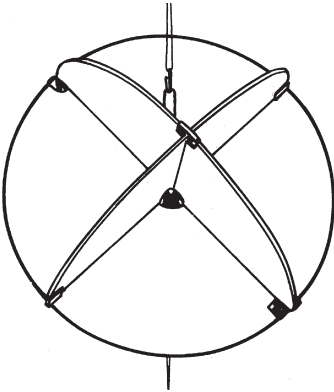

#157 Surface Mount System

Allows hard surface or rail mounting of #152 or #153 radar reflectors. Base measures 2.75 x 3.75" (7 x 9.5 cm). Surface or rail mounting makes sense on a hard top, masthead or spreader, navigation hazard, dock piling, or as an aid to navigation.

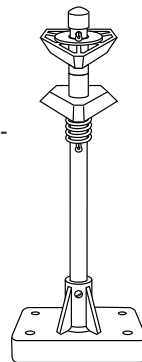

For Echomaster installation instructions, see page 10.

RADAR REFLECTOR DESIGN

A professional radar reflector produces a much stronger return of the radar signal than might be expected from its modest dimensions.

The **conventional radar reflector** consists of three mutually perpendicular metal plates which, viewed together, form a pocket (Fig. 1). If one of these pockets were to be placed on a flat surface (Fig. 2), a line rising perpendicularly from the flat surface to the peaked junction of the three sides of the plates would be called the "axis of symmetry." The inner sides of the pocket, which form the corners of the reflector, reflect the radar signal back to its originating source with high levels of effectiveness over angles that vary from the axis of symmetry by 20° or more.

Figure 1

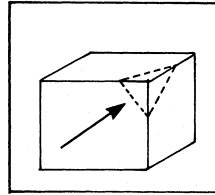

ONE CORNER OF TRIANGULAR CORNER REFLECTOR

Figure 2

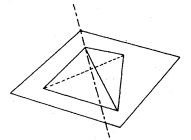

AXIS OF SYMMETRY

The **Echomaster radar reflector**, an octahedral cluster of eight pockets, uses the principle of the axis of symmetry to full advantage (Fig. 3). In the "catch rain" position, it allows three of the pockets of the reflector to be depressed 20° and three of the pockets to be elevated 20° . With the radar reflector oriented in this manner, the Echomaster assures the highest probability of detection from all points surrounding the boat.

Figure 3

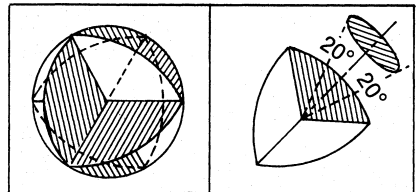

OCTAHEDRAL CLUSTER

AXIS OF SYMMETRY



In the "catch rain" position, optimum 360° azimuth coverage is provided, azimuth being the great circle about a fixed reference point (the reflector).

Deluxe Echomaster 153 in the "catch rain" position (automatically obtained by using the harness system).

An understanding of the radar echo pattern for an Echomaster mounted in the "catch rain" position may be gained from Figure 4.

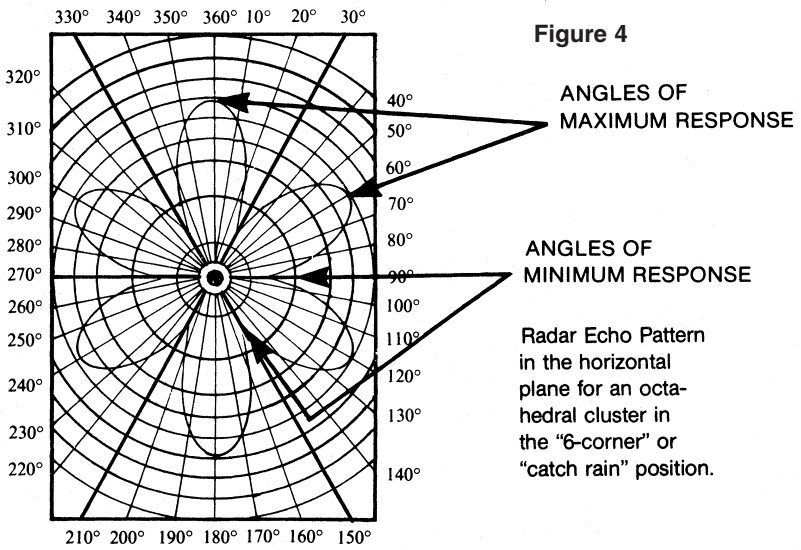

Reflectivity. A flat metal plate placed at a right angle to a radar beam will always reflect the maximum amount of energy. Curved surfaces will reflect much less, and the effectiveness deteriorates as the curve becomes more acute.

A flat metal surface perpendicular to the radar signal gives a high amount of reflected return.

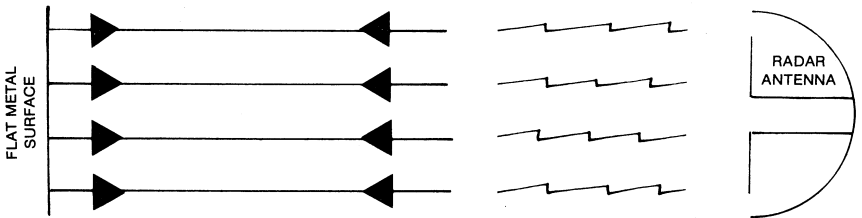

A slanted surface will reflect much less due to reflection of most of the signal in a direction other than the radar signal source.

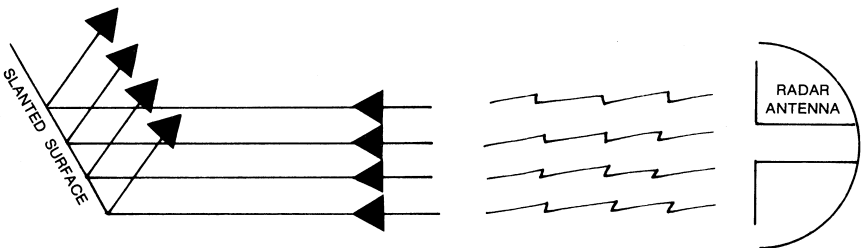

On a curved surface, such as a metal mast, only a very small area will reflect the signal back; the rest is lost at numerous acute angles.

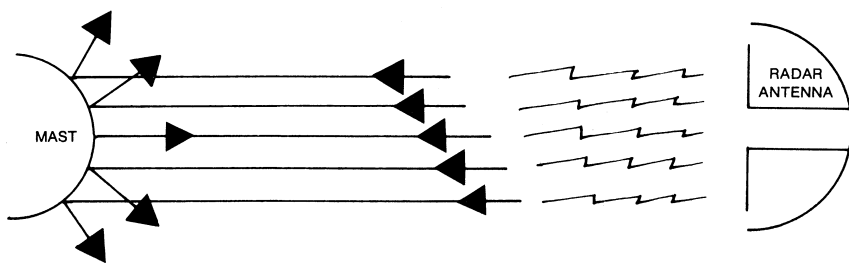

Reflections from a corner reflector with circular plates, such as Echomaster, are almost as effective as a plain, flat metal surface.

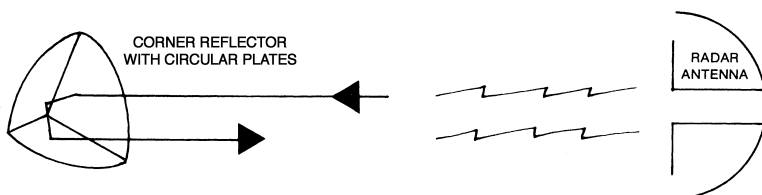

Radar frequency. The frequency of the radar in use has a marked effect on the amount of signal that is returned from a given sized reflector. Higher frequency or shorter wavelength radars produce much brighter returns. Fortunately, the majority of marine radars operate in the relatively high frequency X or 3 cm band.

Radar cross section. A worldwide standard has been set for making meaningful comparisons of various reflective surfaces: the “effective radar cross-section,” referred to as σ_m . This value, σ_m , is useful in stating a “figure of merit” for the performance of radar reflectors.

A reflector’s performance, the amount of signal that it will reflect, is stated in terms of the diameter of a metal sphere which would produce an equivalent radar response (Fig. 5).

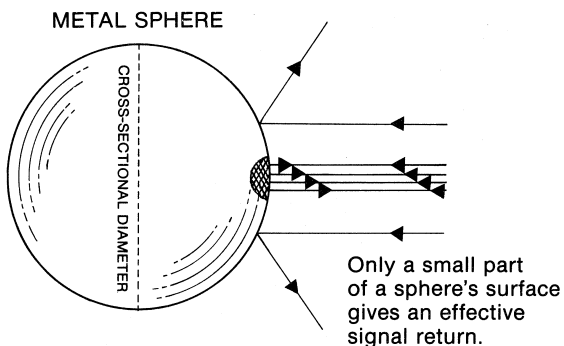





Figure 5

Plate Design. Radar reflector plates can be triangular, circular, or square. The table below shows relative performance:

RADAR REFLECTOR CONFIGURATIONS and PERFORMANCE

CONFIGURATION OF AN INDIVIDUAL CORNER		RELATIVE MAXIMUM RADAR CROSS SECTION, σ_m	RELATIVE MAXIMUM RADAR DETECTION RANGE, R_m	$\sigma_m =$
Triangular Plates		1	1.0	$\frac{4 \pi a^4}{3 \lambda^2}$
Circular-Sector Plates		4	1.4	$\frac{16 \pi a^4}{3 \lambda^2}$
Square Plates		9	1.7	$\frac{12 \pi a^4}{\lambda^2}$

a = short side of corner; λ = radar wave length 3 cm for standard marine radars

Note that a reflector with a circular plate, such as Echomaster, has four times the effective radar cross-section as the triangular reflector, the most commonly seen type. While the square plate design is even more effective, it is seldom used in marine systems due to its non-compatibility with sails and rigging, which must survive in a chafe-free environment, and also due to its extra weight and high vulnerability to windage.

The definition of σ_m is arbitrary, and can be somewhat misleading. σ_m increases very rapidly as radar reflector dimensions are increased (σ_m varies as the 4th power of dimensions). Radar detection range, R_m , increases much more slowly (R_m varies directly with the radar reflector dimensions). For practical purposes, however, doubling the size of the radar reflector will not usually double the detection.

Alignment of reflector plates. An essential design feature of any reflector, one which greatly enhances the effective amount of signal returned, is the flatness of the plates and the accuracy of the right angles formed between them. Alignment of each angle must be within 3° of a right angle or half of the reflected signal will be lost. A misalignment of all three plates by as much as 2° will have the same effect. Davis Echomaster plates resist flexing and warping, and the corner latching system ensures minimal angular distortion.

Conclusion. The use of a professional radar reflector enhances your boating fun, knowing that safety has been part of your cruise preparation. The Davis Echomaster utilizes advanced octahedral design for maximum effectiveness of signal return. The plates erect quickly and easily in correct “catch rain” position—and require little room for stowage.

ECHOMASTER INSTALLATION

Positioning the Reflector

Cabins, deckhouses, sails, stacks, etc. have a “shadow effect,” blocking a radar signal. To minimize this, the reflector should be fitted as high as possible. Height also helps eliminate the effect of heavy sea and swell conditions which might otherwise blend the observed signal into sea clutter on the radar display.

Avoiding shadowing by the sails is important. In the diagram at right, radar beams in the shaded sector are not reflected well because the sails, if wet, shadow the radar reflector. Higher mounting minimizes this.

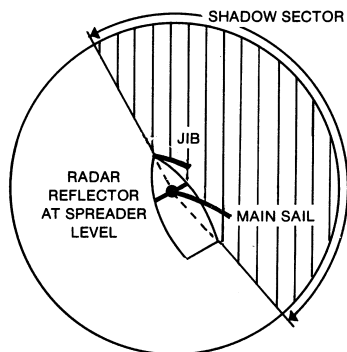

To better illustrate the advantage that can be gained by placing the radar reflector higher above the water, study the table below.

REFLECTOR HEIGHT		DISTANCE TO RADAR HORIZON	
5 ft.	(1.5 m)	2.5 nautical miles	(4.6 km)
10 ft.	(3.1 m)	4.0 nautical miles	(7.4 km)
15 ft.	(4.6 m)	4.5 nautical miles	(8.3 km)
20 ft.	(6.1 m)	5.5 nautical miles	(10.2 km)
25 ft.	(7.6 m)	6.0 nautical miles	(11.1 km)
30 ft.	(9.1 m)	6.5 nautical miles	(12.0 km)
35 ft.	(10.7 m)	7.0 nautical miles	(13.0 km)

The values in the table are not directly proportional, since radar waves are bent from a straight line path toward the earth as they travel outward from a ship's antenna. Refraction, or bending, is due to the density and water vapor content of the atmosphere, allowing X band waves to travel about 6% beyond the optical or line-of-sight horizon. Values in the table are approximate; reliable detection ranges for common radar reflectors seldom equal the radar horizon distances indicated above.

If you have a radar installation on your boat, it may be necessary to keep the Echomaster reflector a minimum distance away from the radar antenna. You should consult with your radar dealer or manufacturer to avoid possible damage to equipment or adverse performance.

Echomaster is designed to mount in the “catch rain” position by being suspended by the halyard/harness system. Alternatively, Echomaster may be permanently affixed to a mast structure.

Suspended by halyard or harness. The orientation shown is the perfect “catch rain” position.

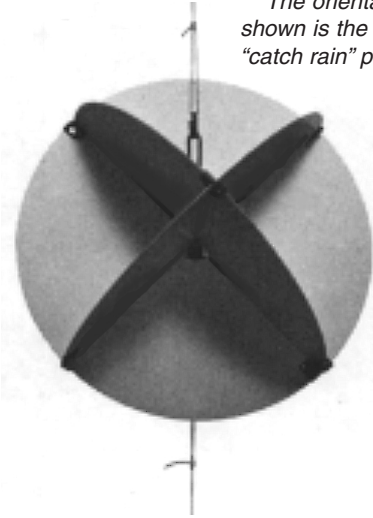

Rigid mounting on a mast structure using pipe fittings. The #157 Surface Mount System could also be used, which would allow the “catch rain” position.

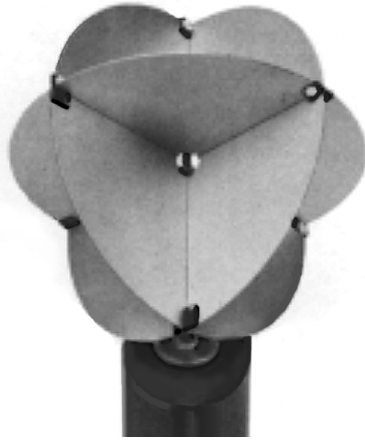

In the “catch rain” position, Echomaster's octahedral cluster orients all panels at 20° to the axis of symmetry. At this angle, all the inner pockets have the unique property of always reflecting a radar signal back to its originating source with high effectiveness. At the same time, optimum 360° azimuth coverage is provided. In addition, the pocket pointing straight up will aid in airborne search and rescue operations.

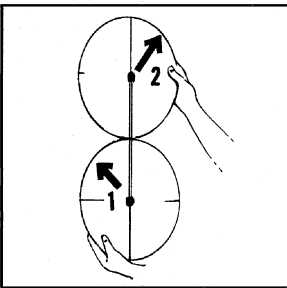

Assembling the Reflector Plates

Slide **full circular plates** #1 and #2 together as shown. Notice that the stamped arrows are to be located side-by-side, in the same corner.

Snap in place the top and bottom plastic **corner latches** that will hold the plates together.

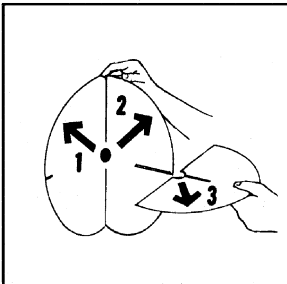

Slide **half plate** #3, with stamped arrow, into position as shown. This brings all three stamped arrows together in the same corner or pocket.

Note: If you intend to mount the Echomaster 152 around a backstay, position plates #1 and 2 against the backstay before sliding on plate #3.

Snap in place the center corner latch on the half plate.

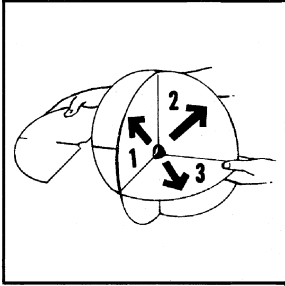

Slide the remaining half plate in place, as shown (reverse this half plate if the corner latches do not match).

Snap in place the three remaining corner latches that secure the half plates.

Mounting Echomaster #152

The standard Echomaster #152 does not include a mounting system. The best way to install this product is to assemble it around a backstay or make your own bridle and hang from holes drilled in the corner latches.

6-Point Temporary Mounting

For infrequent, temporary mounting, a rope harness can be constructed as shown here.

Cut 6 equal pieces of 3/16" diameter (5 mm) line, each about 18" (45 cm) long. Tie each one to a corner latch of the reflector with a bowline knot as shown. Locate the 3 corner holes which include the 3 stamped arrows. Group these three attachment lines and tie to the hoisting halyard. This will automatically place the reflector in the "catch rain" position if all three corner lines are the same length. Attach the 3 remaining support lines to a downhaul halyard. Suspend the reflector vertically as high as possible.

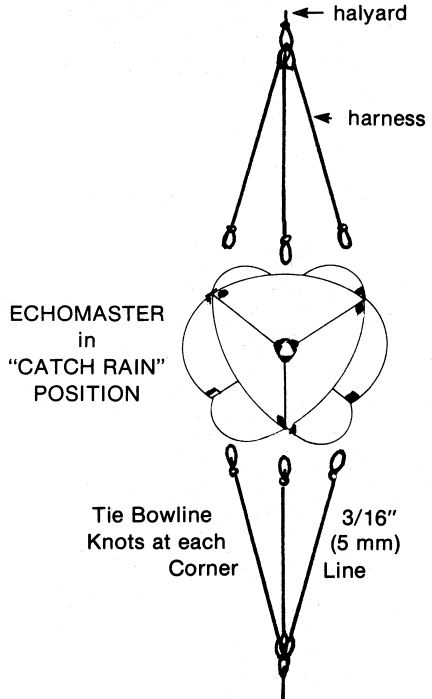

Mounting Echomaster #153

Step 1. Place the assembled reflector in the “catch rain” position with the three stamped arrows in the “up” position. Assemble one flat washer and one mounting block onto a harness wire as shown below. Push the wire up through the center-hole of the radar reflector.

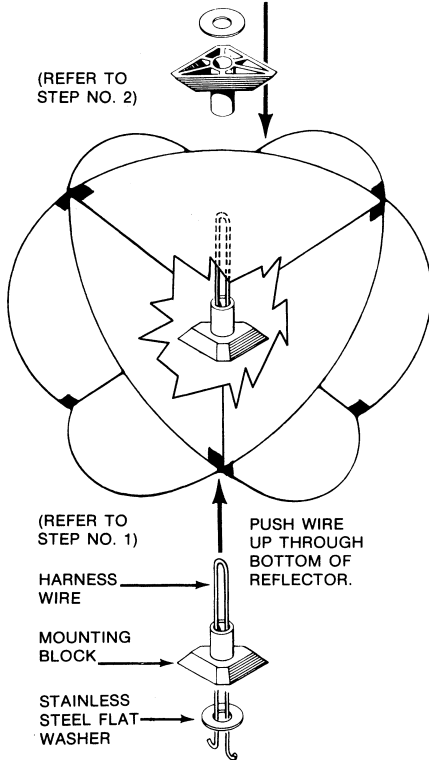

Step 2. Assemble the other mounting block and washer onto the closed end of the wire protruding through the top of the reflector.

Step 3. Link the two wires together as shown:

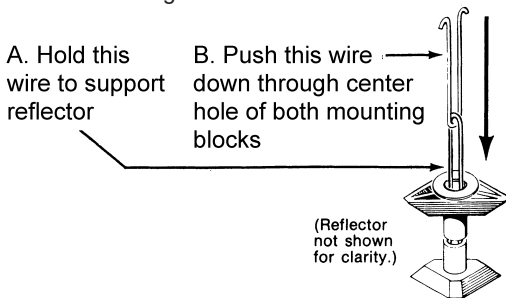

Step 4. Clip the cotter rings onto the closed end of the wires. Secure the six corner latches on the reflector with the six 1/4" (6.4 mm) nylon nuts and bolts supplied.

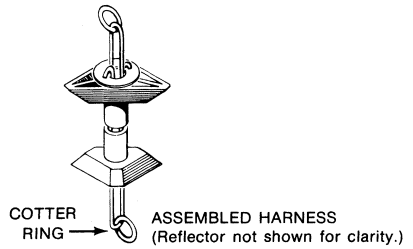

Suspending the Echomaster from a Spreader

Two small sheaves can be installed about 8" (20 cm) apart on the spreader, as shown here:

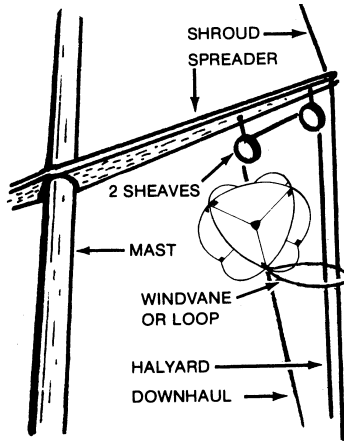

Then, using a 3/16" (5 mm) braided dacron line as a halyard and the harness of the Echomaster attached, the reflector can be hoisted to within 10" (25 cm) of the spreader. Many other solutions are equally satisfactory; however, to minimize wear and chafing on the suspension lines, we recommend the system shown here.

Although rotation and bouncing in the wind do not degrade Echomaster's performance, free-spinning in one direction and then the other can fray the support lines, leading to possible breakage. To limit spinning, secure a tie line to the side, or add a "windvane tail" to a hole in one of the six corner latches of the reflector. The "windvane tail" consists of a 1/8 to 3/16" (3.2–4.8 mm) line, extending 20–24" (50–60 cm). It stabilizes the reflector as the wind increases.

Using the #157 Surface Mount System

The Davis #157 allows permanent installation of an Echomaster reflector on a hard surface or a railing up to 1.25" (32 mm) in diameter. Fasteners are not included. 1 1/2" U-bolts required for rail fastening.

Note: The #157 system cannot be used on the discontinued Echomaster model #153.

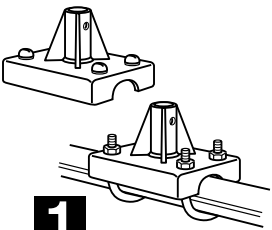

1
Install mounting base to flat surface or railing.

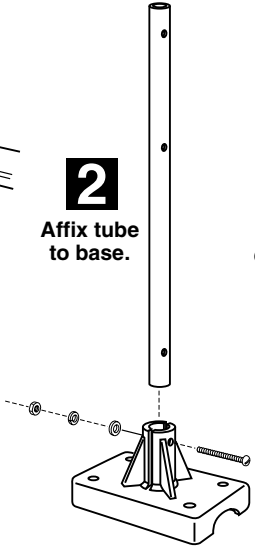

2
Affix tube to base.

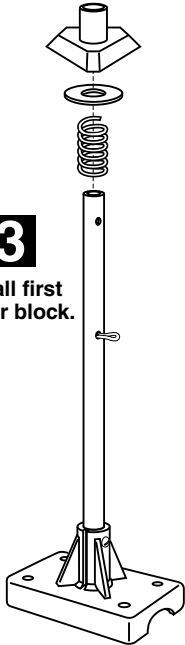

3
Install first corner block.

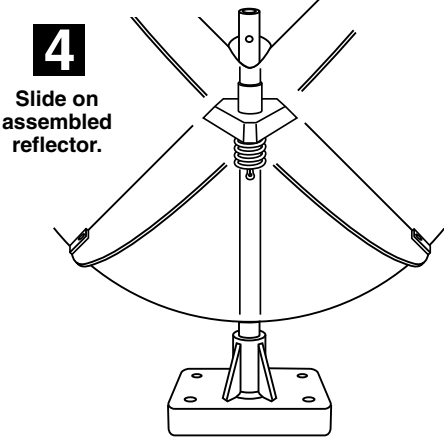

4
Slide on assembled reflector.

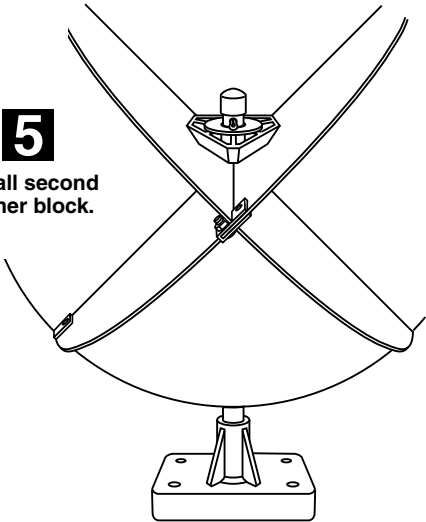

5
Install second corner block.

Echomaster Maintenance

If any reflector plates should become bent, flatten them as well as possible in order to obtain the high reflective performance for which the Echomaster has been designed.

The plates should be washed free of salt water occasionally.

WARNING: No matter what method was employed to mount the Echomaster, it is the responsibility of the user to make periodic inspections of lines and fittings to insure that no condition is developing which could lead to mounting failure and possible injury.

Davis Instruments wishes you many years of happy and safe boating with your advanced design Echomaster Radar Reflector.

Replacement Parts

Echomaster replacement parts may be obtained from your dealer or Davis Instruments.

Echomaster 152, Standard

#R152F

Corner Latches and Rivets (3 each)

#R155E

Radar Reflector Booklet

Also Available from Davis:

EMERGENCY **RADAR REFLECTOR**

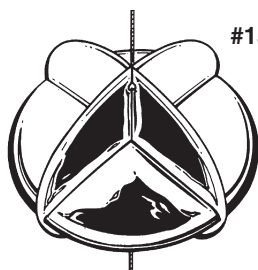

Excellent as a back-up aboard larger vessels or primary reflector on smaller boats that might not normally carry a radar reflector. Made of plastic-metal foil laminate. Opens in seconds and is very lightweight. Performs almost as well as Echomaster (see performance diagrams on page 4). 11.5" (29 cm) in diameter. Stows flat. Economical enough for any boat. Recommended "best buy" by *Practical Sailor*.

Davis Instruments

3465 Diablo Ave., Hayward, CA 94545 U.S.A.
Phone (510) 732-9229 • Fax (510) 732-9188
info@davisnet.com www.davisnet.com