



DESSALATOR[®]
watermakers - dessalinisateurs

AC PRO COMPACT – D90 to D200

90 to 200 liters/hour – 230V (or 400V)



ASSEMBLY AND USER MANUAL

Dessalator[®]

ZI des 3 Moulins
282 rue des Cistes
06600 Antibes, France
www.dessalator.com
contact@dessalator.com

Table of Contents

Table of Contents	2
Copyright / Disclaimer.....	3
List of Components.....	4
Assembly	7
1) List of supplies necessary for assembly	7
2) Seawater inlet.....	8
3) Motor/Pump Block	10
4) Electric connections.....	11
5) Membrane Block.....	12
6) Control Panel.....	13
7) Mini-Command (optional)	14
Start-Up	15
1) Precautions before start-up	15
2) Starting-up the watermaker	16
3) Stopping the watermaker: without rinsing of the membranes.....	17
4)	17
5) Stopping the watermaker : with automatic rinsing of the membranes	18
6) Using the Mini-Command (optional)	19
Operation	20
Maintenance	21
1) Membranes maintenance	21
2) Rinsing frequency of the membranes	21
3) Sterilizing the membranes	22
4) High-pressure pump	22
Spare Parts	23
Appendix A1: How do watermakers work?	24
Appendix A2: Mounting of the DESSALATOR® high-pressure nozzles.....	25
Appendix A3 : Manual Rinsing Procedure	26
Appendix A4 : Instructions for the Sterilizing Cartridge	27
Appendix A5 : Troubleshooting.....	28
Appendix A6 : Guide of the Indicator Lights of the	29
Appendix A7 : Circuit diagram of the electronic board.....	30
Appendix A8 : Schematic drawing	31

Copyright / Disclaimer

Dessalator®

ZI des 3 Moulins, 282 rue des Cistes

Bâtiment Euro 92

06600 Antibes, France

www.dessalator.com

contact@dessalator.com

+33 4 93 95 04 55

List of Components

Vanne de coque



- Must be placed as low as possible in the boat so as to avoid drawing in any air.
- Must be installed towards the back for a motorboat, or centered near the keel for a sailboat. The ribs of the strainer should be placed towards the front the boat to force the entry of water by scooping during navigation.
- The strainer of the hull valve helps stop large particles at the entrance of the system.
- The sea water filter is fixed directly on the valve (photo opposite).

Bloc de préfiltres



- Must be placed as close as possible to the hull valve and, if possible, beneath the waterline to ensure a better yield/output.
- The first cartridge of 25 microns roughens the filtration, then the second cartridge of 5 microns refines the treatment.
- Comes with a tool for screwing / unscrewing the tank.
- Comes equipped with a solenoid valve for automated rinsing.

Pré-pompe eau de mer



- The pre-pump is equipped with a 3-way valve (for manual rinsing)
- Must be placed as close as possible to the hull valve and, if possible, beneath the waterline to ensure a better yield/output and must be remain accessible.
- On the valve, pressurized fresh water must be connected to facilitate manual rinsing and sterilization of the watermaker; see the layout diagram at the beginning of the manual.

Tip: Do not forget the 2 stainless steel clamps at each junction.

DO NOT PLACE THE PUMP WHERE THERE IS A RISK OF WATER SPRAYING

Front Control Panel

The control panel is incorporated into the chassis (**COMPACT** version).

It is used to manage the operation of the watermaker and is made up of the following elements :

- A high-pressure manometer.
- A flowmeter.
- A start switch.
- A Manual or Automatic mode selection switch (optional).
- A knob for pressur adjustment.
- An operating hours countern.
- Three indicator lights.



Motor/Pump Block

- The HP motor/pump block allows seawater to be pushed to 60-65 Bars.
- Composed of the 230 or 400 Volts motor.
- Must be installed in a ventilated space.
- The engine block is incorporated in a frame with the integrated control panel for the **COMPACT** version.

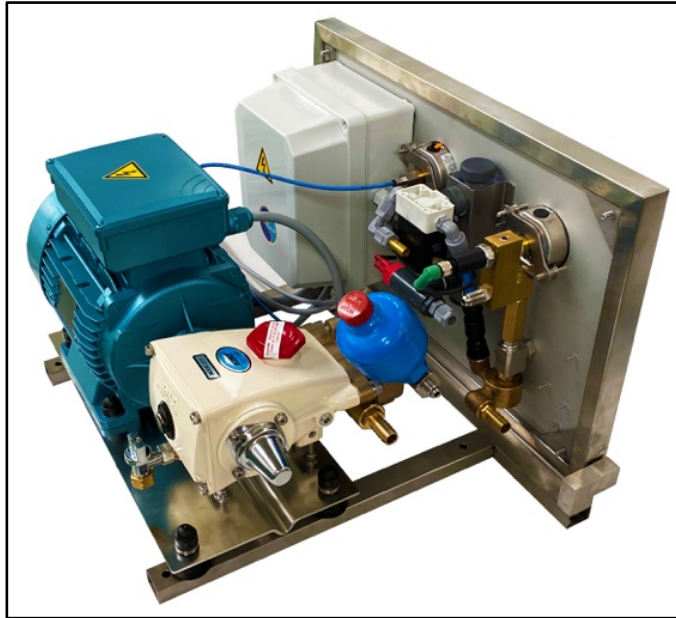

Membrane Block

The number of membranes depends on the desired production rate : 90 to 200 liters/hour.



1 membrane for a production of
90 liters of water per hour.
(1200x100x120mm).



2 membranes for a production of
160 liters of water per hour.
(1200x190x120mm).



3 membranes for a production of
200 liters of water per hour.
(1200x270x120mm).

Piping (supplied by Dessalator®)

- High-pressure piping from the pump to the membranes and from the membranes to the control panel. An 8-meter pipe is provided, it should be cut into two parts. The length of each part is to be determined according to the distance of the different element.
- 4 special DESSALATOR® fittings* for high-pressure piping (see assembly procedure in **Appendix A2**).
 - * Including one 90° elbow fitting for the back of the control panel, which can swivel 360°.
- Fresh water production piping going from the outlet of the membrane block to the dashboard (6 meters long).

Assembly

1) List of supplies necessary for assembly

- Screws (self-tapping and more).
- Stainless steel ties Ø 8-16mm, Ø 12-22mm and Ø 16-27mm.
- Electrician' plastic ties.
- *Loctite 542* liquid or *Loctite 577* paste.
- Polyurethane sealant, Sicaflex or equivalent.
- Corrugated sheath for electric cables and high-pressure tubes.
- Braided-core flexible hose, Ø 10mm and Ø 12mm inner diameter (Tricoflex) and 3mm thick.
- Various tools (drills, saws, Ø 21mm hole saws, etc.).

2) Seawater inlet

Seawater inlet valve

- The strainer should be placed as low as possible beneath the waterline so that it does not draw in any air. It should be placed far from the discards.
- Pierce the hull with a Ø 21mm hole saw.
- The streaks of the strainer must be placed towards the front of the boat to allow the water to naturally enter by scooping during navigation.
- Seal the junction with the hull properly using polyurethane sealant or Sicaflex. Do not forget to paint the submerged part with special underwater paint.
- The hull valve ⑤ must remain accessible for maintenance operations.
- Seal the valve/strainer and valve/hose connections with *Loctite 577*.

Sea water pre-pump

- The pre-pump must also be installed below the waterline for better production and must be easy to access.
- The pre-pump is equipped (at its suction) with a 3-way valve.
- On the 3-way valve : for seawater suction from the pre-pump (seawater inlet valve side) the connection must be made with Tricoclair-type piping with an internal Ø19mm ① and the other side of the 3-way valve (rinsing side) of internal Ø15mm ②.
- The connection for rinsing with fresh water ② must be made with water from the circuit of the pressurized fresh water unit.
- The discharge from the pre-pump to the block of pre-filters ③ must be done with *Tricoclair* type piping with an internal Ø15 mm.
- The valve handle ④ must be swung to the seawater position (see **Appendix 3** for the 3 positions of the 3-way valve
- As an option, a fixing bracket is available to fix the pre-pump to a vertical wall..

➔**Note** : For manual rinsing, switch the valve handle to the soft water position (see the 3 valve positions below) and follow the instructions in **Appendix A3**.

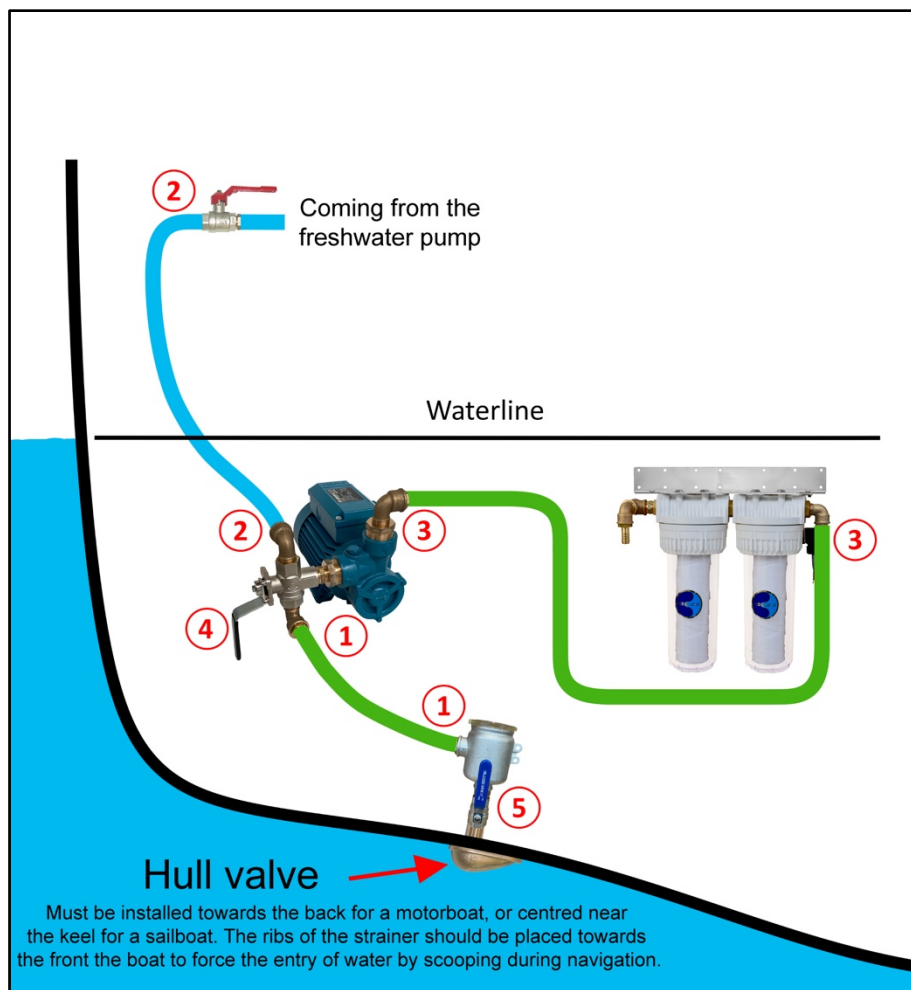

Cartridge pre-filter block

- The prefilter must also be installed beneath the waterline to ensure a better yield/output. It must be easy to access
- The fixing bracket is reversible to allow you to adjust the installation height.
- Piping connections must be made with Tricoflex Ø15 mm (inside diameter), for the entire seawater system ③ as well as the pressurized rinsing system
→ Do not forget to fasten 2 stainless steel collars on each fitting.
- Allow a minimum of 3 cm below the filter body for the clearance of the tank when opening it. A screw is provided for screwing / unscrewing it.
- A solenoid valve is mounted behind the pre-filter for automatic rinsing.

Connections

- Fasten two stainless steel collars on each connection, with the clamping heads positioned opposite one another.
- This connection can be made by tapping under a sink, a washbasin as well as on the path of pressurized cold water pipes.
- If the pipes are to pass through walls or be in contact with sharp corners, provide protection against wear and friction by inserting them into a sheath or pipe of greater diameter.

3) Motor/Pump Block

- To ensure optimal production, the assembly of the high-pressure motor block must be completed as low as possible in the boat, in a horizontal position and in an area protected from water sprays.
- Use the 2 stainless steel legs ① under the 2 motors to fix the motor block. Leave a few centimetres of wiggle room around it.
- Provide sufficient airflow for the ventilation of the motors.
- The connection of the prefilter outlet ② to the inlet of the pump on the suction-side pump ③ should be done using Tricoflex piping Ø 12mm (inside diameter) and 2 stainless steel collars at each connection.
- The connection of the pump's high-pressure head to the membrane inlet (red mark) should be done using a high-pressure hose that is cut to size (follow closely the assembly instructions in **Appendix A2**).
- Put a little liquid *Loctite* or threadlock on the male and female cones before each connection.

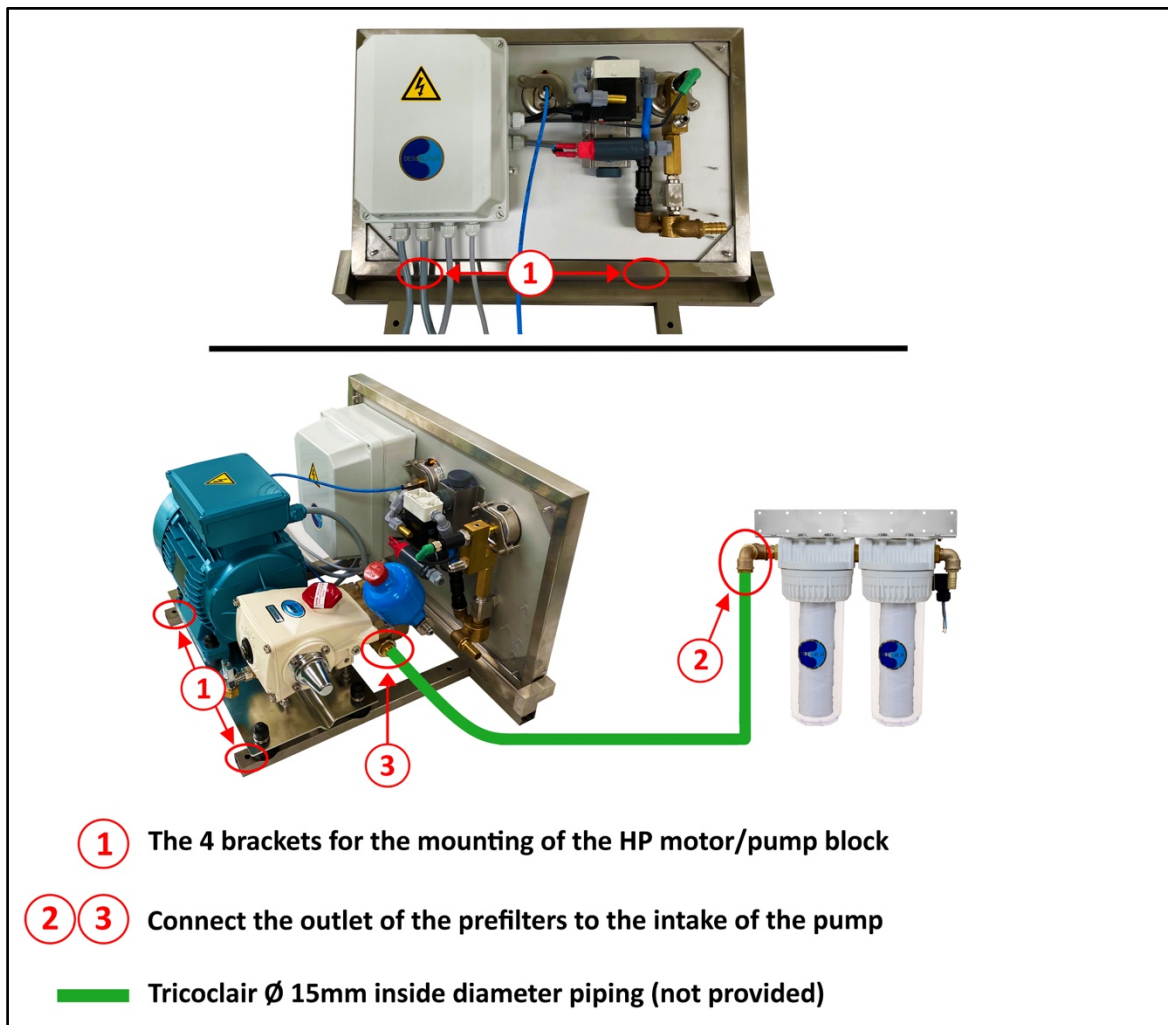

4) Electric connections



WARNING!

Never work with the power on! Turn off the power of your entire system.

The 230V (or 400V) motor connection:

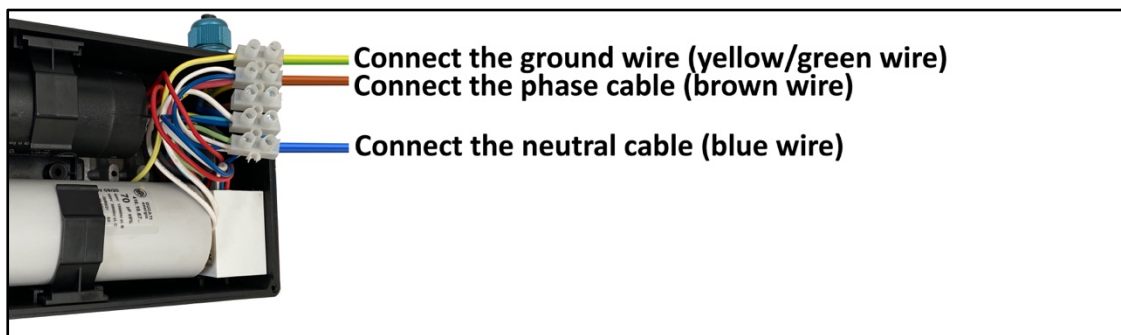

Pre-pump connection :

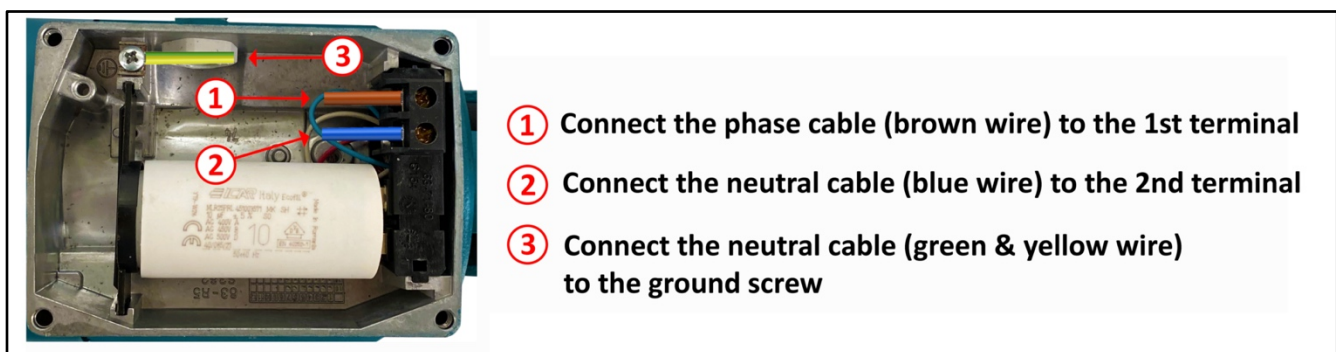

5) Membrane Block

- The membrane block should preferably be mounted horizontally (on the base or side). A vertical position might lead to a yield/output loss over time.
- Fastening is done using self-tapping screws in the stainless steel brackets **①**.
- It is necessary to sheath the pipe connecting the output of the high pressure pump **②** to the inlet of the membranes **③** because of the vibrations, which might lead to leaks if the pipe is attached or in direct contact with something.
- The installation of the high-pressure nozzles must be carried out according to their assembly instructions (see **Appendix A2**).
- Put some *Loctite* or threadlock on the 2 male and female cones before tightening.
- Available as an option: 90° elbow high-pressure nozzle for the inlet and outlet of the membranes **④**.

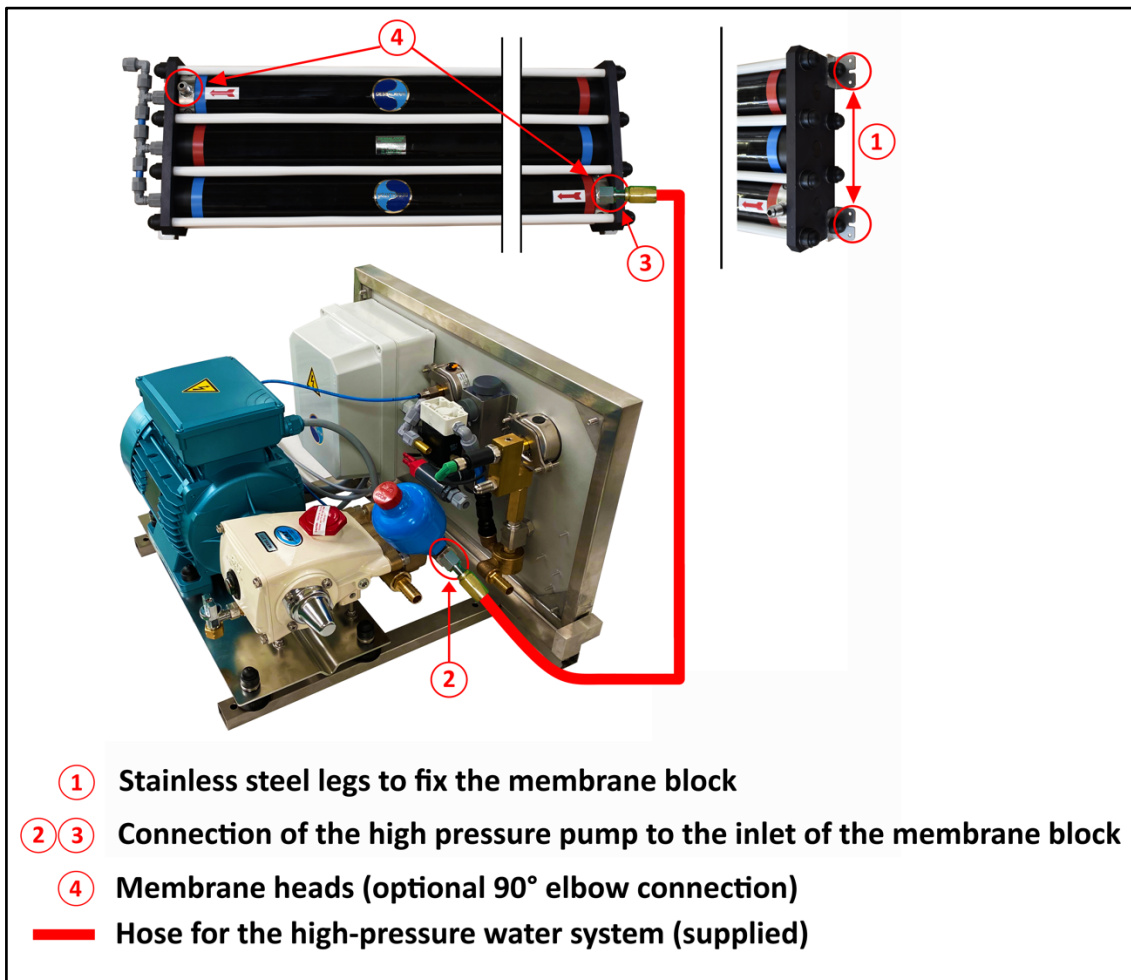

6) Control Panel

The control panel must be mounted on a vertical panel.

Ensure unrestricted access to the back of the control panel, this will make connections easier. You should place it in a place where the light indicators are visible. Example: below or on the sides of cupboards, under the chart or centre table, on the front panel of a rear berth etc.

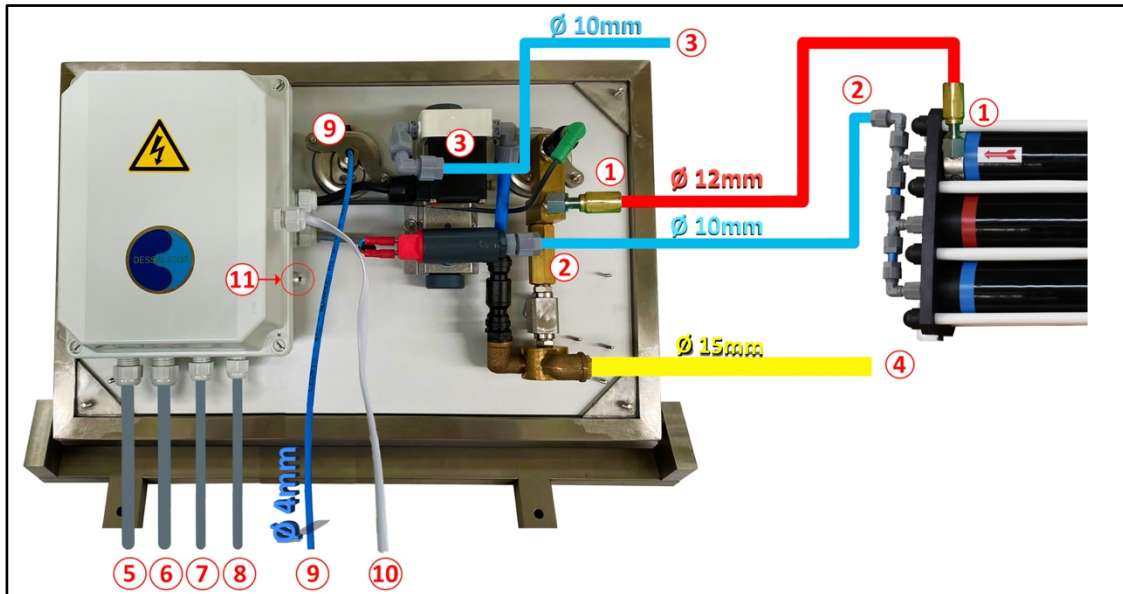

- ① Hose for connecting the high-pressure membrane outlet to the high-pressure control valve on the back of the front panel. (Black high-pressure hose supplied)
- ② The blue Serto hose for connecting the water outlet of the membranes to the inlet of the probe of the panel. (inside diameter \varnothing 10mm pipe supplied).
- ③ Hose for connecting the fresh water outlet of the panel to the tanks, dispensing clarinet or water inlet or with a tee provided that there is no valve on the outlet of the water tank (inside \varnothing 10mm pipe not supplied, use preferably Tricocclair).
- ④ Hose to connect the discharge of panel. To be connected preferably to a water disposal system like the evacuation of a sink, washbasin, cockpit etc. In this case, do not forget to open the drain valves during use (inside \varnothing 15mm pipe not supplied).
- ⑤ 230V (400V) cable power supply of the electrical box to connect to the output of the circuit breaker.
- ⑥ Motor power supply cable.
- ⑦ Pre-pump power supply cable.
- ⑧ power cable for the rinsing solenoid valve located on the pre-filters.
- ⑨ 4mm capillary tube. It connects to the LP pressure gauge and is connected to the side of the HP pump.
- ⑩ Micro-Command (ou Mini-Command) power supply cable.
- ⑪ Reset fuse if the pre-pump turbine is blocked.

7) Mini-Command (optional)



General presentation:

The Dessalator® Mini Remote Control Dessalator allows you to monitor the watermaker and turn it off.

You can start and shut down the machine simply by pressing a single button on the Mini Remote Control. The 3 light indicators on the Mini Remote control have the same functions as the 3 lights on the watermaker itself.

You can also program the automatic shutdown of the watermaker after a given time of operation.

The Mini Remote is very intuitive, which is why this quick guide only describes the basic functions and is meant to serve as a convenient reference

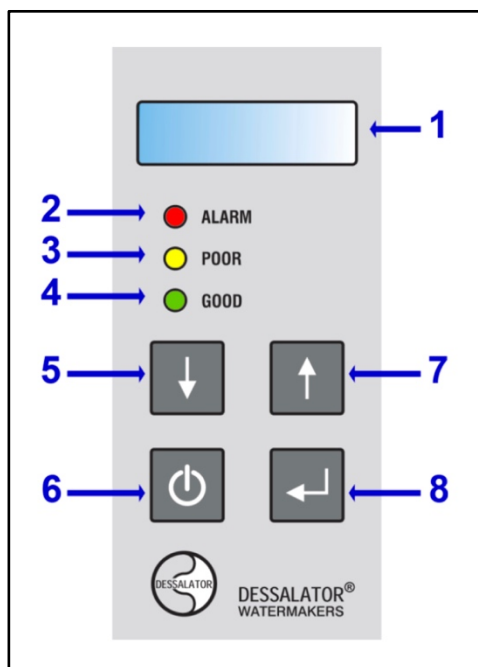

- 1: DISPLAY
- 2: RED LIGHT – ALARM
- 3: YELLOW LIGHT – POOR QUALITY
- 4: GREEN LIGHT – GOOD QUALITY
- 5: DOWN BUTTON
- 6: ON / OFF BUTTON
- 7: UP BUTTON
- 8: ENTER / CONFIRM BUTTON
- 9: DISPLAY TEXT LINE 1 – STATUS/INFO
- 10: DISPLAY TEXT LINE 2 – STATUS/INFO



➔ **Note** : in the event of an alarm, the machine must be restarted from the control panel (and not from the Mini-Command or Micro-Command).

Start-Up

1) Precautions before start-up



WARNING!

Before starting-up, check that the valves are open

Mandatory:

- When using the device for the first time, after changing the filter, after the boat has been grounded or stopped for a long time, you should flush the system using fresh water by operating the three-way valve on the prefilter (see **Appendix A3**).

Purge the system for 1 minute: watermaker must be stopped and the pressure regulator open (counterclockwise).

- Once the system is filled, put the valve back in seawater position (see **Appendix A3**).

➔Note: If you are not going to use the watermaker at all for a month or more, we recommend to either sterilize the membranes for storage (for a maximum duration of 6 months) or to rinse it out at least once a month.

Before starting the system back up, we recommend rinsing it out for two minutes (see **Appendix A3**).

2) Starting-up the watermaker

Follow the procedure below :

- Set the switch ① to “MANUAL” and press the “START” button
- The pre-pump starts, the needle on the low pressure manometer ③ rises in the green zone.
- Once the engine has started, gradually turn the pressure regulator knob ④ to the right to increase the pressure towards the middle of the orange zone ⑤ then continue gradually increasing the pressure until it reaches the green zone ⑥ on the pressure gauge.

This pressure build-up procedure should last approximately 1 minute.

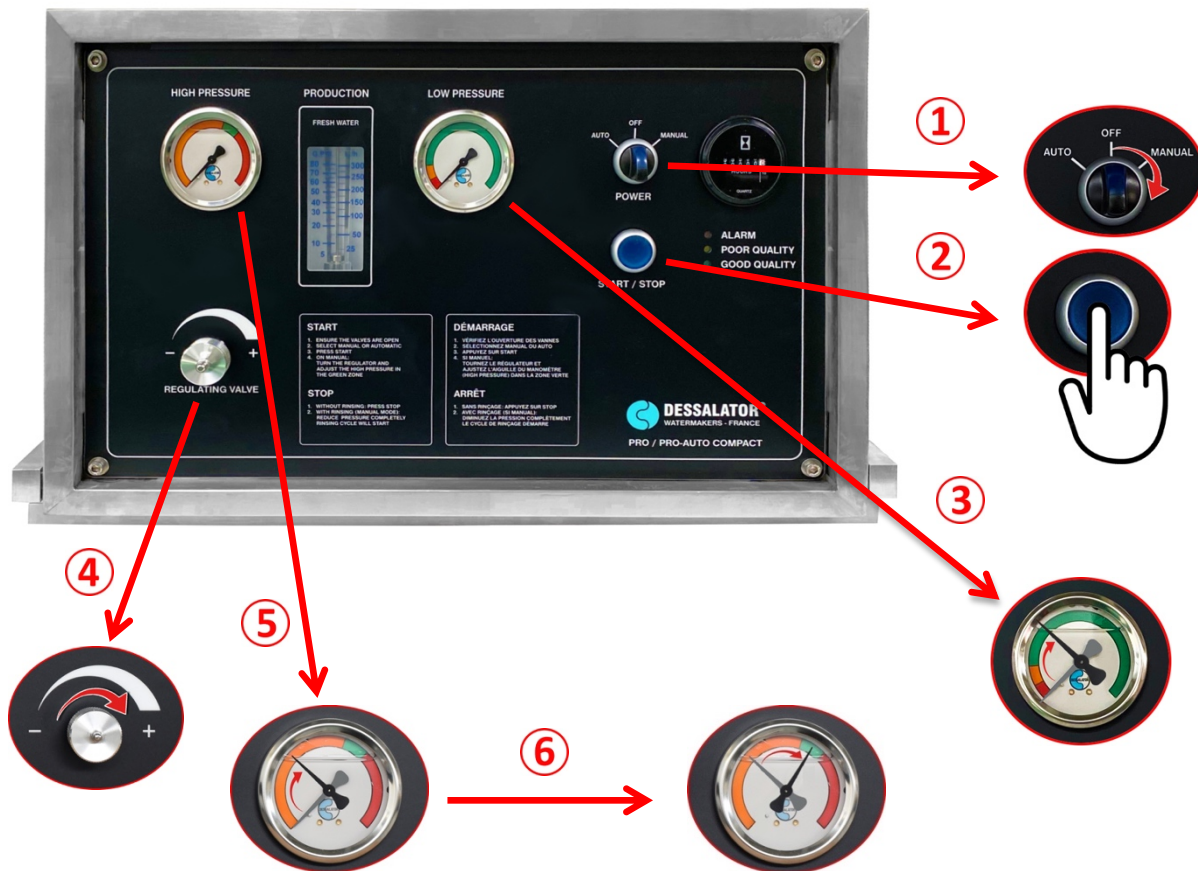

➔ **Note** : Too high a pressure setting stops the watermaker and turns on the red light. In this case, decrease the pressure with the pressure regulation knob ④ and repeat the startup procedure.

The fresh water yield depends on the temperature and salinity of the sea water and the cleanliness of the 5 & 25 micron filters (in the pre-filter).

3) Stopping the watermaker: without rinsing of the membranes

It is not necessary to rinse your membranes if you use your watermaker regularly.

Follow the procedure below :

- Set the switch ① to « OFF » or on the Mini-Command press on  (optional, follow the procedure on the paragraph 6).
- You can now lower the pressure regulator knob ② to the left (counterclockwise) until the needle of the high pressure gauge ③ is at the minimum.
- Once the knob has come to a stop, reopen the pressure regulator knob ② by only ¼ of a turn (to the right).



Beyond 10 days without use, it is best to rinse the membranes before the watermaker is started-up again (see manual rinse procedure in **Appendix A3**).

If watermaker is not used, the rinsing is to be renewed every month.

If the watermaker is not used completely, the membranes must be sterilized for storage (for a maximum of 6 months).

5) Stopping the watermaker : with automatic rinsing of the membranes

A rinsing must be carried out if the watermaker is not going to be used for more than 10 days.

Follow the procedure below :

After using the watermaker, **do not turn it off**.

- While the watermaker is still running, Start turning the knob of the pressure regulator ① (counterclockwise) to engage the rinsing mechanism, the pressure of the manometer will drop.
- Once you have reached the end stop, reopen the pressure regulator knob ① by only ¼ turn (to the right).
- The watermaker will stop producing water and will start the rinsing procedure. The green and yellow LEDs on the control panel ② will light up, indicating that the rinsing procedure has started. This should last 30 seconds and stop automatically. The green and yellow LEDs ② will turn off and the only remaining indicator will be the flashing blue LED on the ON/OFF switch ③, you can turn off the system by position the switch ③ to « OFF ».



Automatic rinsing is the best way to rinse your system because it not only replaces seawater with fresh water, but it also washes your pre-filter and allows discharge to the sea through the suction through-hull all dirt and debris accumulated in the filters.

6) Using the Mini-Command (optional)

Once you start-up the system for the first time using the control panel, you can use the Mini Remote Control to perform the following: monitor the state of the system, stop or schedule a delayed shutdown.



Stopping the watermaker WITHOUT rinsing of the membranes:

Directly on the Mini-Command (or Micro-Command) by pressing the  button until you hear 2 confirmation beeps that indicate that the watermaker is going to shut down and enter stand-by mode.

➡Note: Only the **AUTOMATIC** versions are capable of restarting the system directly from the Mini-Command (or Micro-Command).

Operation

Membranes are delicate components

Reverse osmosis membranes must be carefully maintained as they are the most sensitive parts of your system. Follow the instructions given to avoid damaging them and voiding the warranty. The nominal production capacity of the watermaker is given for a temperature of 25°C for seawater and depend on the salinity of the seawater in your navigation area. Each degree below this given temperature decreases the flow rate by 2.5 to 5%.

Extremes temperatures

The membranes should not be exposed to temperatures below **0°C**. Overpressure, caused by expansion resulting from freezing, can rupture the membranes and prevent the salt from being filtered out.

The membranes must not be exposed to temperatures above **60°C**, as high temperatures may also prevent salt from being removed.

Drying out of the membranes

After the first use, the membranes should be kept immersed in liquid, either in treated seawater, in a mix of fresh water and sterilizing solution or, temporarily, in fresh water (see Sterilization methods, **Appendix A4**).

Recommendations for use

The different quality and salinity level of seawater influence the yield of the membranes.



WARNING!

Do not use this system in areas where the water is muddy or polluted and at the mouth of rivers or brackish water. This will prevent clogging the prefilter and damaging the membranes.

Maintenance



WARNING!

In case of risk of frost, we recommend emptying the flowmeter located on the control panel, disconnect the output pipe (blue) and blow or inject air into this pipe while alternating pressing on the small button of the solenoid valve located at the back of the control panel. You should also protect your membranes against the cold using blankets or insulation.

1) Membranes maintenance

Over time, it is normal for the flow to drop by 10 to 15%.

If yield/output is no longer satisfactory, you should consider replacing the membranes.

The output volume of your watermaker is established within the first 24 to 48 hours of operation. The fresh water output depends on the salinity and temperature of the seawater, as well as on the working pressure of the membranes.

Rinsing the membranes can improve the yield/output.

2) Rinsing frequency of the membranes

It is therefore not necessary to rinse the membranes after each use. Rinsing them too often can lead to premature deterioration of the membranes.

There are two methods to flush the system: one manual and the other automatic.

Both methods use the water in the boat's tanks.

It is necessary to rinse the watermaker if it is not going to be used for several days.

➔**Reminder:** All flushing procedures should be done with the **motor/pump block off**.
The biggest enemy of membranes is **pressurized fresh water**.

3) Sterilizing the membranes

Membranes sterilizing procedure

1. Easy method **using** the ST2 sterilization cartridge (reusable):
We have developed a sterilization cartridge that greatly facilitates handling. The instructions for this cartridge are given in **Appendix 4**.
2. Manual method **without** the ST2 sterilization cartridge:
With the watermaker turned off, thoroughly rinse it for 10 minutes with fresh water using the 3-way valve on the prefilter. Pour the sterilizing product (whole bag) into a bucket containing 8 litres of water. Uncouple the seawater inlet pipe and immerse it in the bucket. Start the watermaker without increasing the pressure until the bucket is empty. Once the bucket is empty and the operation completed, reconnect the pipe.
3. Method using a garden sprayer:
Pour the sterilizing product (whole bag) into a bucket containing 8 litres of fresh water and mix everything together. Fill the garden sprayer with this mixture and increase the pressure to 3 or 4 bar. Then inject the sterilizing solution at the inlet of the membranes (red mark side).

4) High-pressure pump

The high-pressure pump is half filled with oil to the level indicated on the gauge. The oil used in the pump is a 15W40 or 20W40 multigrade oil. You not exceed the level (as shown on the gauge). The oil does not need to be change over time.



The tape placed on the red oil filler cap of the high pressure pump is only there for transport: it must be removed before use.

Spare Parts

DESSALATOR® devices, which have a high reliability and long lifetime, generally do not require costly servicing. An accident is always possible (operation with low water level, accidental overpressure, impact, etc.).

We keep the following spare and maintenance parts at your disposal:

- 5µm and 25µm 10-inch filters
- Production solenoid valve
- High pressure pump seals and valves
- High pressure hose, sold by the meter
- Nozzle for high pressure piping
- Salinity probe
- Pressure sensor

Accessories:

- Mini Remote Control
- Micro Remote Control
- Complete ST2 sterilizing cartridge
- Sterilizer in sachet
- Mineralizer cartridge
- Mineralizer in sachet
- Nipple for high pressure tube
- HP nozzle elbow

Appendix A1: How do watermakers work?

How does reverse osmosis work?

Pressurized seawater enters the membranes which, similarly to "molecular sieves", only let the fresh water molecules pass.

Most of the dissolved solid particles do not cross the membranes. These residues are evacuated with the discharge water.

Reverse osmosis extracts 99% of impurities.

The drinking water produced by your reverse osmosis system can be consumed. If stored in your tanks you can, if needed, treat this water with commercially available products. Make sure to follow the manufacturer's dosage instructions.

We sell a mineralizing cartridge if you plan to drink the produced fresh water long-term.

How does your watermaker work?

Seawater is drawn in through the inlet valve of the thru-hull. It then passes through the 5-micron prefilter. The filtered water is then pressurized in the membrane tube by the high-pressure pump (operating pressure is in the green zone of the pressure gauge). The pressurized water passes through the orifices of the membrane surface, freed from the salt and bacteria, which are poured back into the sea along with the remainder of the solution used to self-clean the membranes. The now fresh water goes through a probe measuring the salt content: if the water is sufficiently desalinated, the 3-way valve is automatically switched to direct the fresh water to the tanks. On the other hand, if the salinity sensor registers a salt content that is too high (conductivity greater than 1,000 μ Siemens), the valve will reject the output water at sea.

The amount of drinking water being produced is controlled by a flowmeter located on the control panel. The fresh water production capacity is given for a seawater temperature of 25°C. Yield is reduced by 2.5 to 5% per degree Celsius of temperature drop.

Appendix A2: Mounting of the DESSALATOR® high-pressure nozzles

1. Screw the brass fitting onto the high-pressure hose counter-clockwise all the way to the vertical mark on the outside of the fitting.

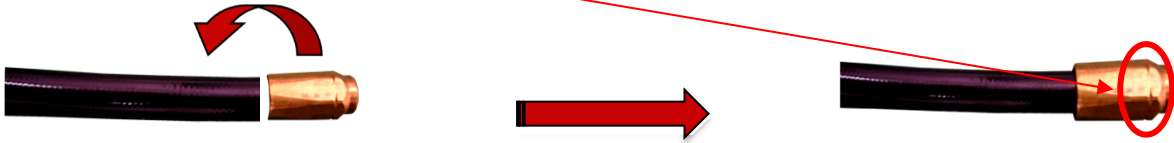

2. Place the brass plug in the stainless steel nut and tighten it firmly:



3. Put a little grease on the tip of the stainless steel cone and screw it by placing it straight in the brass fitting. Stop as soon as the stainless steel thread has disappeared in the brass nozzle, i.e. about 7 mm of space between the nut and the brass fitting.



4. Unscrew the nut of the conical adapter. The nozzle is ready for the pipe from the pump to the membrane. Sheathing is with another pipe is a good idea to protect it against vibration.



5. **IMPORTANT:** Make sure that the nozzle has not clogged the pipe :
 - Either by blowing into the pipe,
 - Or by inserting a screwdriver to check that the passage is free.

Do not forget to put Loctite or threadlock on the male and female cones when reassembling.

Appendix A3 : Manual Rinsing Procedure

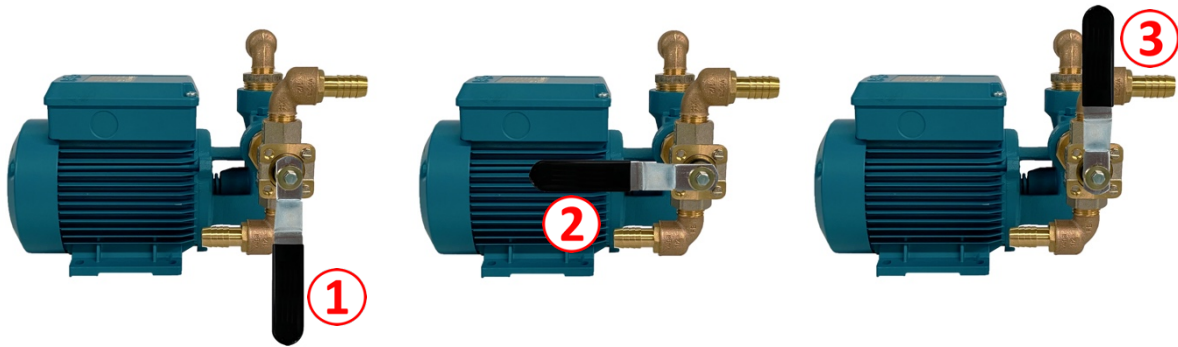

- ① The valve is in the seawater position for use in desalinization mode.
- ② The valve is in the closed position, to change the filter cartridge (see **Appendix 4**) or isolate the water circuit.
- ③ The valve is in the fresh water position for manually rinsing the circuit with fresh water or for performing sterilization (see below).

Your **DESSALATOR®** is equipped with automated rinsing, here is the procedure to follow if you choose manual rinsing

Normal position normale :



Normal seawater use position:

The valve handle is in seawater position.

For manual rinsing, tilt the handle of the 3-way valve upwards to the fresh water position (see below), let the circuit rinse for approximately one minute then reposition the valve downwards to the sea water position (see below).

Manual rinsing position :

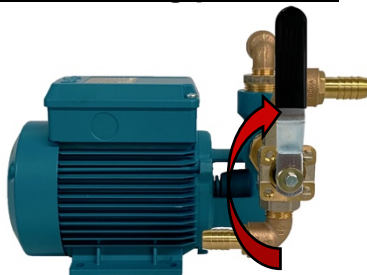

Manual rinsing and sterilization:

Place the valve handle on the fresh water position

Appendix A4 : Instructions for the Sterilizing Cartridge

With the watermaker OFF :

- Close the seawater inlet valve.
- Open the sterilizing cartridge: **be careful not to lose the O-ring**
- Remove the top screen.
- Place the foam at the bottom of the filter.
- Pour the sterilizing powder into the cartridge.
- Replace the top screen and close the cartridge.
- Check that the seal is correctly in place.
- Remove the 5 and 25-micron cartridge from the prefilter.
- Replace it with the sterilizing cartridge.
- Turn the rinsing valve towards fresh water under pressure for about 20 seconds.
- The watermaker should be OFF.
- Duration of sterilization: 6 months maximum (to be repeated beyond that)



Remove the 5 and 25-micron cartridge from the prefilter



Replace the 5-micron cartridge with the ST2 sterilizing cartridge

➔ **Important** : Before the next start-up, rinse the system out using fresh water for 10 minutes. Remove the ST2 sterilizing cartridge and replace it with a 5-micron cartridge.











WARNING!

The ST2 cartridge can be reused

Appendix A5 : Troubleshooting

PROBLEM	POSSIBLE CAUSES	SOLUTIONS
Leak on the pressure regulator located behind the control panel	Control cable gland is loosened	- Tighten the cable gland with a 12 mm open-end wrench
The high-pressure pump is noisy	-Reduced water inlet or air inlet - Not at the right pressure	- Check the diameter of the pipes, the tightening of the clamps and the cleanliness of the filter. - Set the pressure in the green zone
Oil leak on the high-pressure pump	Gaskets on connecting rods are worn	- Replace the gaskets
Insufficient water flow	Water is too cold	- N/A
	Pre-filter is dirty	- Replace the pre-filter.
	Power supply is too weak	- Recharge the batteries. - Check the connections.
	Voltage drop in the electric cable	- Install a cable with a larger section
Water leaks under the high pressure head	Worn gaskets	- Replace the piston gaskets
Pressure is not rising	Dirty pump valves	- Remove and clean the valves in the pump head

Appendix A6 : Guide of the Indicator Lights of the Mini-Command and Micro-Command

INDICATOR LIGHTS	DESCRIPTIONS AND ACTIONS
	Test upon starting-up the test When these indicator lights remain on, please open the regulator (-) to lower the pressure.
	The pumps are started, waiting for working pressure Slowly turn the pressure regulator clockwise (+) until the needle of the pressure gauge is in the green area.
	Working pressure reached, waiting for good water quality Please wait, once the water quality is good the machine will automatically start to produce water.
	Water production The water quality is good, drinking water is being produced
	Automatic rinsing Please wait, the rinsing takes 30 seconds
	Low pressure The pressure is too low
  	Alarm 1-1: down time - low pressure Did this alarm ring after the pump started first? If so check the seawater inlet valve and the pre-filter. Restart and try again. Alarm 1-2: No power to the pressure sensor If this alarm sets off after the machine start, it could be a failure of the pressure sensor or the system voltage could be too low. Alarm 2-1: Pressure too high Switch off the watermaker, fully open the regulator (-) and restart the machine.

v1.3 081220

Legend: Indicator lights are on



Indicator lights are flashing



Indicator lights are off



Appendix A7 : Circuit diagram of the electronic board

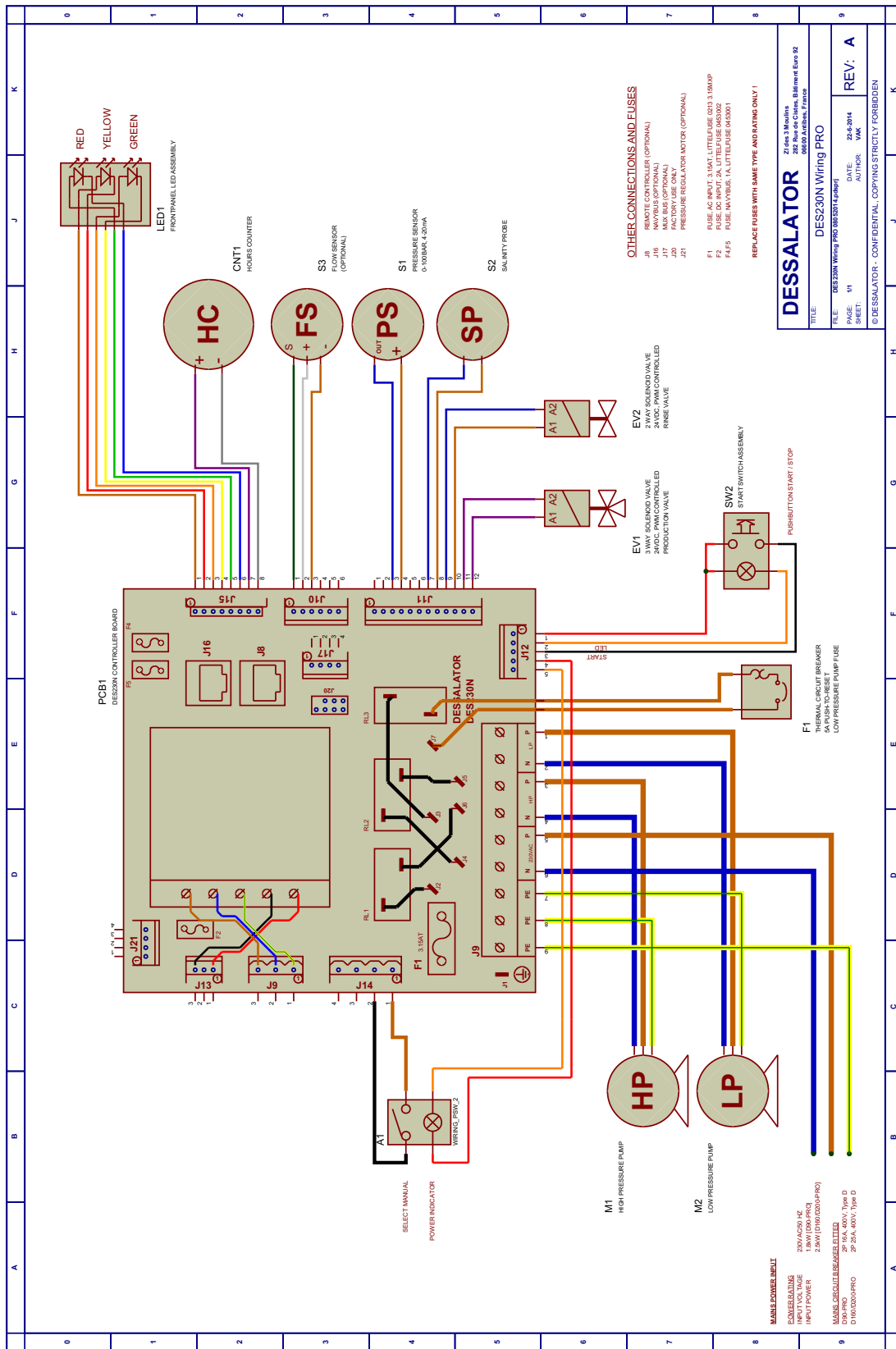

Appendix A8 : Schematic drawing

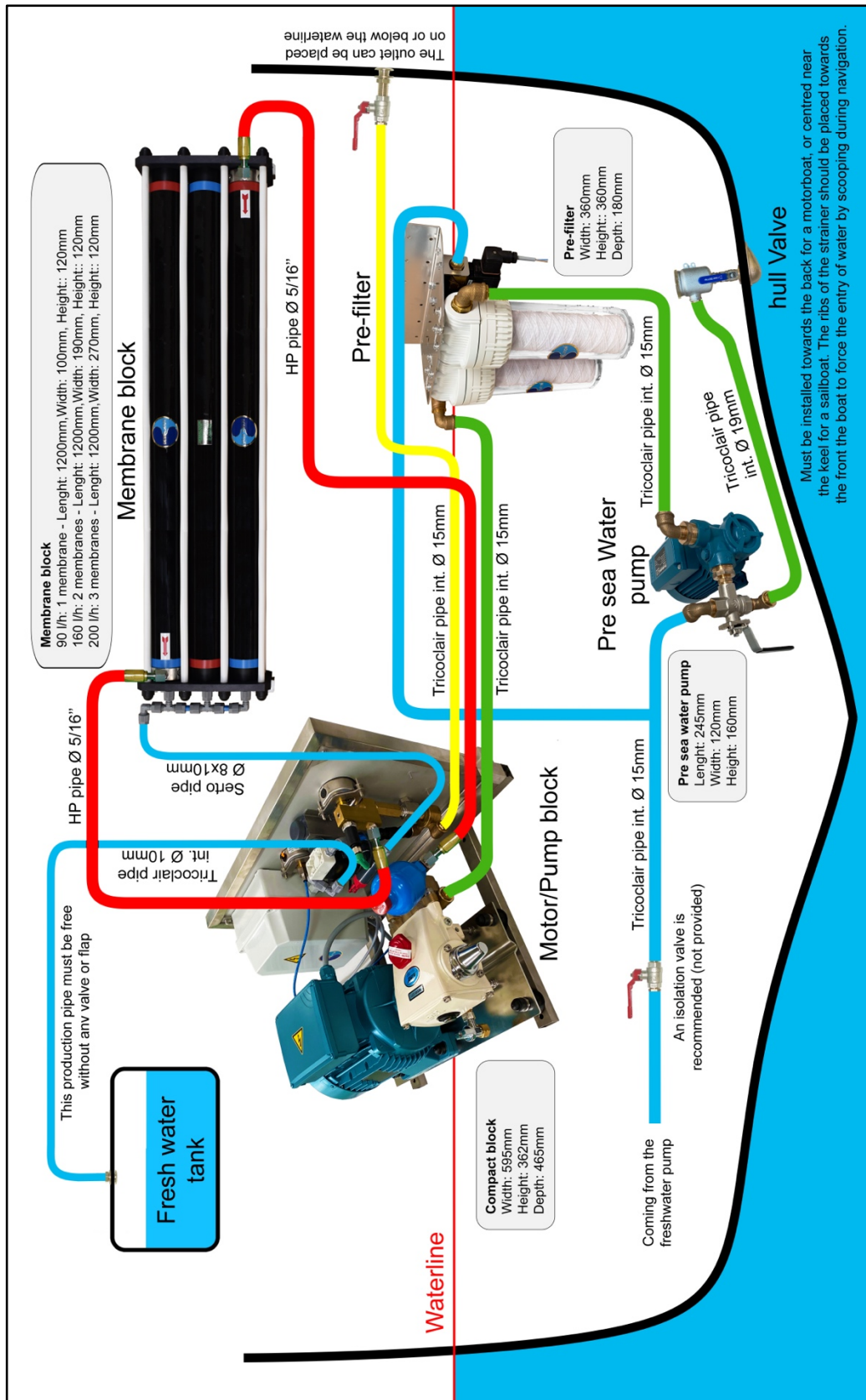

Dessalator®

ZI des 3 Moulins, 282 rue des Cistes
Bâtiment Euro 92
06600 Antibes, France
www.dessalator.com
contact@dessalator.com
+33 4 93 95 04 55