



Quality Marine  
Equipment Since 1981

# MAX PROP

AUTOMATIC FEATHERING PROPELLERS

## EASY / WHISPER INSTRUCTION MANUAL 2, 3, 4 & 5 BLADES

For installation videos visit  
our website.

[WWW.MAX-PROP.COM](http://WWW.MAX-PROP.COM)

# INTRODUCTION

Thank you for having chosen a Max-Prop automatic feathering propeller for your vessel. This instruction booklet is designed to answer all your questions on installation and use of the Max-Prop. Please read the instructions carefully and verify the correct working of the propeller before installing it on your boat.

## IMPORTANT NOTES

The propeller is shipped already assembled (unlike Classic Max-Prop models). The rotation (left or right hand) and pitch has been determined at the time of the order and is therefore ready to be fitted on the shaft. Please note that Max-Prop parts are NOT interchangeable so make sure that if you receive more than one propeller (for a catamaran for example) you do NOT interchange parts.

## WHATS INCLUDED

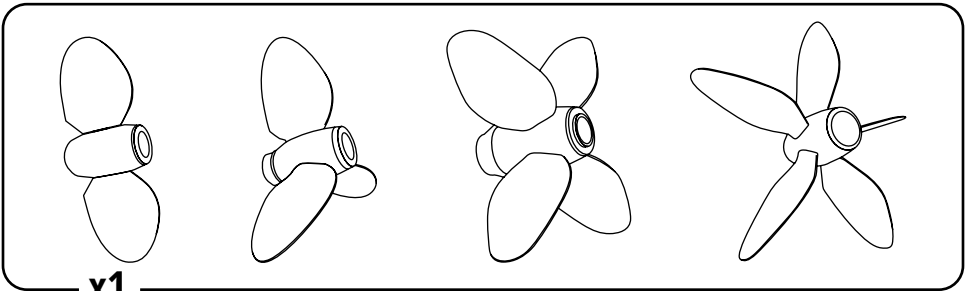

**x2**  
Shaft Nut Locking Bolt

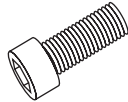

**x3**  
Zinc Bolt

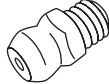

**x1**  
Grease Fitting



**x2**  
Pitch Locking Screw

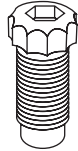

**x2**  
Pitch Adjustment Bolt



**x1 or 2**  
Grease Plug

**For 99mm Hubs Only**



**x3**  
Anode Adapter Bolt

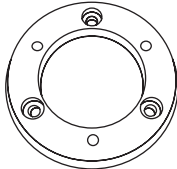

**x1**  
Anode Adapter

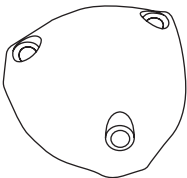

**x1**  
Zinc Anode

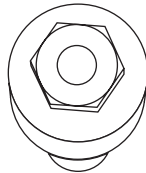

**x1**  
Shaft Nut

# INSTRUCTIONS

1. Fit the propeller onto the propeller shaft, just like a fixed propeller. Be sure that the key is the proper dimension and that the hub slides completely onto the shaft. If you are not sure, remove the key and slide the propeller onto the taper making a mark on the shaft where the propeller stops on the shaft. Re-insert the key and slide the propeller on to the shaft, if it slides up to your mark, it is fine. If not, you will need to file down the sides or top of the key until the hub slides to your mark with the key in place.

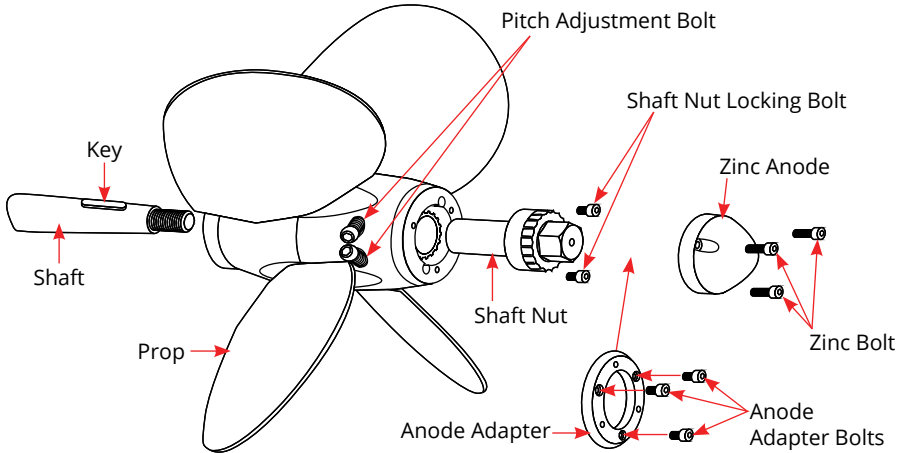

Fig.1

2. Firmly tighten the nut onto the shaft. Align the groves in the base of the nut with the groves in the central hub, so as to obtain two complete holes allowing insertion shaft locking bolts. Secure the nut in place by using the two shaft locking bolts.
3. On 99mm propellers with the anode adapter ring. Fit the anode adapter ring and secure in with the 3 bolts supplied.
4. Fit the zinc and secure it with the three allen bolts. Make sure that the zinc and the propeller are clean to insure good contact.
5. Fill the prop with marine grease (supplied) using a grease fitting (supplied) inserted into the grease holes on the side of the propeller marked "GREASE". The Max-Prop Easy propeller works properly only if the central body is completely filled with the correct grease. Verify that the grease is oozing from the rotating joints between the central part and the hub, so that all of the moving surfaces are perfectly greased. The grease used must be a type of grease approved by Max-Prop so it will remain fluid after years of use and will not get too stiff in cold water. Follow steps 4.1 through 4.9 on page 3. We recommend Lubriplate 130AA calcium based grease.

**TIP:** Watch our YouTube video on how to grease a propeller, visit [https://youtu.be/Pr\\_aEjgugjM](https://youtu.be/Pr_aEjgugjM)

Or scan the QR code with a mobile device.



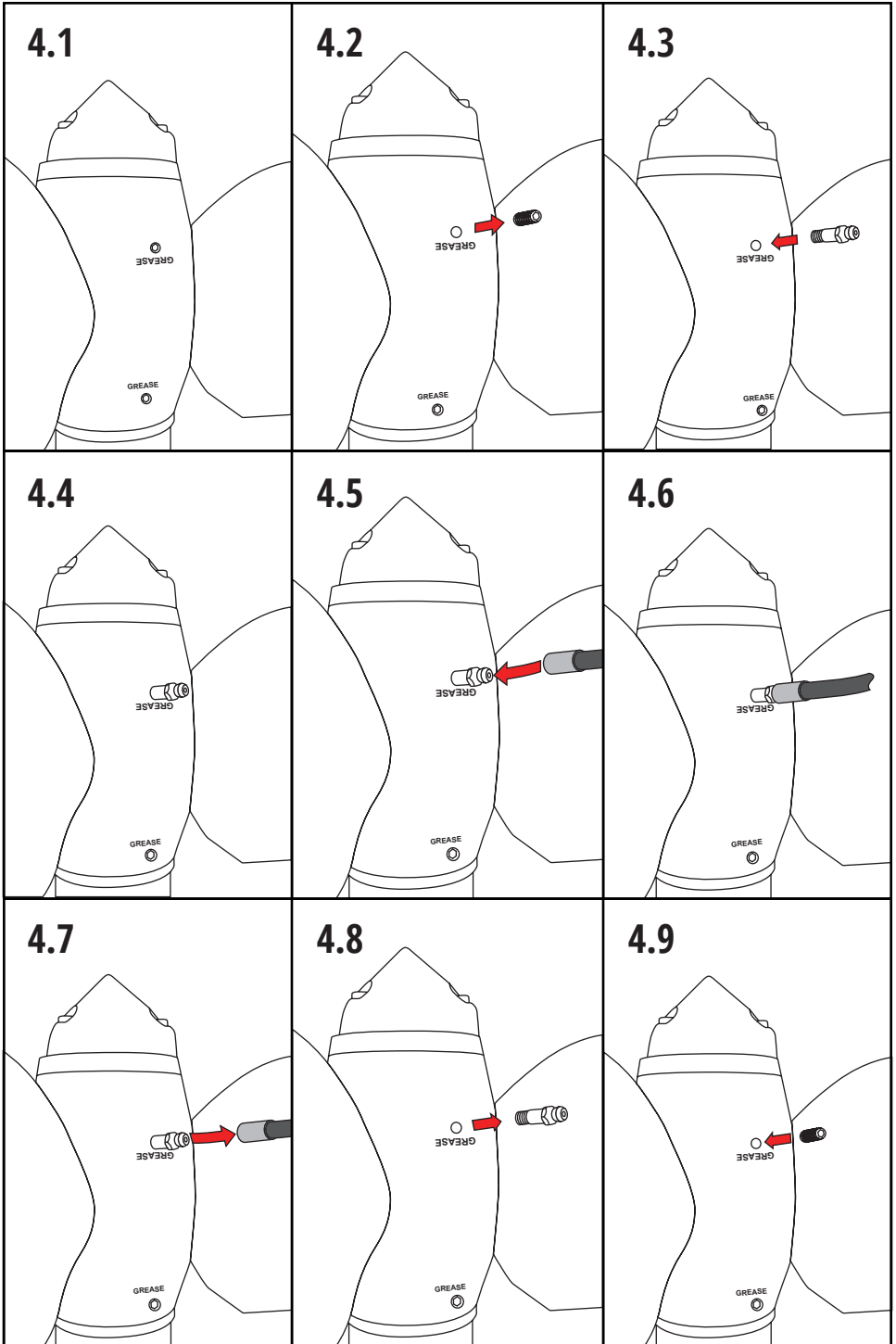

3 \* Repeat these steps with the forward fitting.

5. Confirm that in the feathered position the blades look like the Fig.2 below.

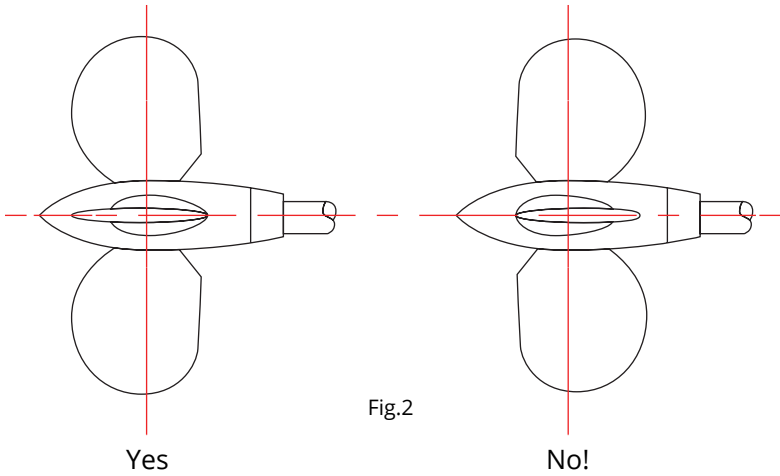

6. Before launching the boat, it is absolutely necessary to operate as follows:

- Hold the propeller shaft.
- Check that the blades of the propeller rotate freely from the forward to the reverse position just by a light effort.
- In the feathered position the blades must be perfectly lined up and set like Fig. 2.
- Confirm that the propeller body is full of grease
- Make sure that the propeller is protected from galvanic corrosion by using zinc anodes on the propeller and the shaft.

## PITCH ADJUSTMENT

The pitch on a Max-Prop changes according to the diameter and the blades rotation angle. Fig.3 below shows the pitch in inches corresponding to the degree of blades angle for a given propeller diameter.

		PROPELLER DIAMETER														
		12"	13"	14"	15"	16"	17"	18"	19"	20"	21"	22"	23"	24"	25"	26"
BLADE ANGLE	10°	4	4.3	4.6	4.9	5.2	5.5	6	6.3	6.7	7.1	7.4	7.7	8	8.3	8.6
	12°	4.8	5.2	5.6	6	6.4	6.8	7.2	7.6	8	8.4	8.8	9.2	9.6	10	10.4
	14°	5.6	6	6.6	7.1	7.6	8	8.4	8.8	9.4	9.8	10.4	10.8	11.2	11.6	12.2
	16°	6.4	6.9	7.6	8.1	8.6	9.1	9.8	10.3	10.8	11.3	12	12.5	13	13.5	14
	18°	7.2	7.8	8.6	9.2	9.8	10.4	11	11.5	12.1	12.8	13.4	14	14.6	15.2	16
	20°	8.2	8.9	9.6	10.3	11	11.6	12.4	13	13.7	14.5	15	15.6	16.4	17	17.8
	22°	9.2	10	10.7	11.4	12.2	12.9	13.6	14.3	15.1	16	16.8	17.5	18.2	18.9	19.8
	24°	10	10.9	11.8	12.5	13.4	14.2	15	15.8	16.8	17.6	18.4	19.2	20.2	21	21.8
	26°	11	12	12.8	13.8	14.7	15.7	16.6	17.4	18.4	19.3	20.2	21	22	22.9	23.8
	28°	12	13	13.9	15	16	17	18	18.9	20	21	22	23	24	25	26
	30°	13	14	15.1	16.2	17.3	18.5	19.6	20.6	21.7	22.8	24	25	26.1	27.3	28.2

Fig.3

Max-Prop Easy and Whisper models are supplied with 5 different forward pitch screws (16° to 24° in 2° increments) as well as 3 reverse pitch screw (16° to 24° in 4° increments)

## INCHES OF PITCH

Diameter and pitch must be calculated as if Max-Prop Easy was a normal fixed propeller. Max-Prop Easy then offers the great advantage of pitch adjustability in order to optimize the performance of the propeller. If the engine does not reach the desired RPM, reduce the blade angle; on the contrary, if the engine exceeds the desired RPM, increase the blade angle.

The Max-Prop Easy allows an angle variation of 2° increments, this corresponds to a variation in the engine RPM of about 13% at the same boat speed. It's possible

to change either the pitch to optimize the engine performance, or the rotation (for ex. if you change the engine, or if there was a mistake when ordering the prop). If you have doubts about the rotation: shaft rotation is determined from the stern of the boat looking forward. With the engine in forward position clockwise rotation of the propeller means it is right hand "R", and a counterclockwise rotation is a left hand "L".

Pitch and rotation of the Max-Prop Easy can be changed as follows:

On the body of the propeller are two threaded bores, marked with letters "R" and "L"; within these bores are placed two bolts.

The pitch of the propeller, both in forward and reverse position, can be easily varied by changing the supplied bolts threaded into the body of the propeller with other bolts of a different length.

The pitch in forward rotation varies by changing the bolts placed in bore "R" if the propeller is right-handed or changing the bolts placed in bore "L" if the propeller is left-handed. The list of the pitch regulation bolts, that are supplied with every Easy propeller is indicated in fig.4.

For example inserting the #20 bolt in the forward rotation and 2 in the reverse rotation will provide a 20° angle for both front position and reverse rotation. Varying 1mm the length of the bolts, blades inclination has a 2° variation

Blade Angle	Right Rotation		Left Rotation	
	Forward Bore "R"	Reverse Bore "L"	Forward Bore "L"	Reverse Bore "R"
16°	16	1	16	1
18°	18		18	
20°	20	2	20	2
22°	22		22	
24°	24	3	24	3

Fig.4

**TIP:** Watch our YouTube video on how to adjust the pitch, visit [https://youtu.be/ghEluSnZI\\_4](https://youtu.be/ghEluSnZI_4).

Or scan the QR code with a mobile device.

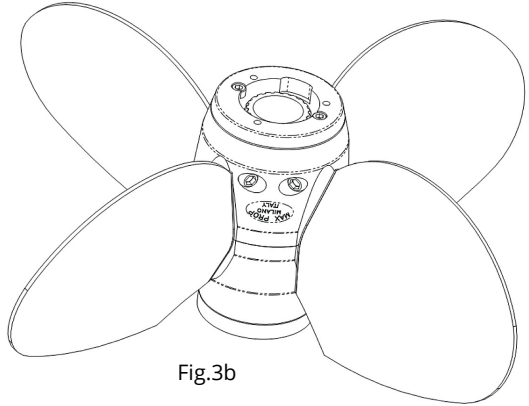

Fig.3b



Fig.5 - Close up of the Left and Right pitch adjustment bolts.

# CHANGING THE ROTATION

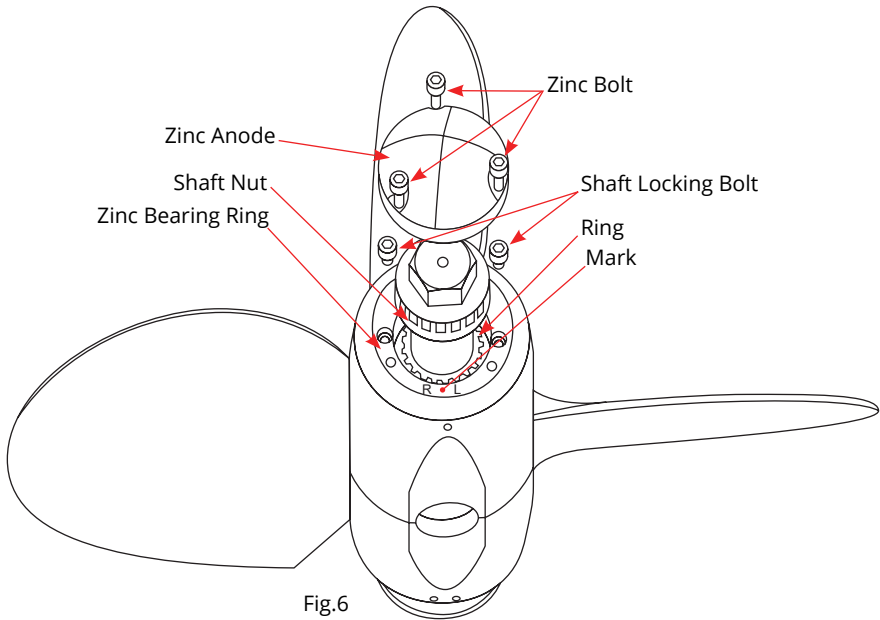

Fig.6

With the Max-Prop Easy it is also possible to change the rotation, e.g. if you change the engine, or if there was a mistake when ordering the prop. If you have doubts about the shaft rotation, it can be determined looking forward from the stern of the boat. With the engine in forward position a clockwise rotation of the propeller means it is right handed(R), and a counter-clockwise rotation is left handed (L).

In order to change the rotation of the Max-Prop Easy, from a right hand rotation to a left hand rotation or vice versa do as follows, referring to Fig.6.

1. Place the propeller in the feathered position. Unscrew the locking-zinc screws, and remove the zinc.
2. Unscrew the locking-nut screws and remove the nut.
3. Remove the Circlip on the aft edge of the hub.



4. Be sure the propeller is in the feathered position, then release the zinc-bearing ring.
5. Once released the zinc-bearing ring, you see that on one tooth of the hub (the aft side) there is a reference mark, and a tooth of the bearing-zinc ring are marked one with "L" and the other with "R".

- If you place the zinc bearing ring in its seat again, matching the “L” tooth with the hub reference mark, you have a left hand rotating propeller, on the contrary, with the “R” tooth you have a right rotating propeller as in Fig.6.

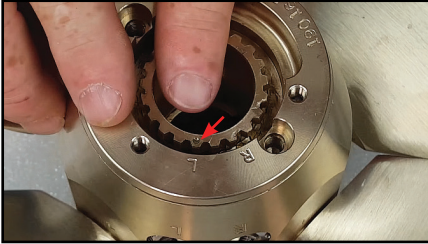

- Replace the “Circlip” in to its seat.
- Tighten the nut and secure it with the locking-nut screws.
- Place the zinc again, and secure it with the 3 proper screws.
- Be sure to change the pitch setting bolts to reflect the pitch setting for the new rotation.**

**TIP:** Watch our YouTube video on how to change the rotation, visit [https://youtu.be/ghEluSnZL\\_4](https://youtu.be/ghEluSnZL_4). Or scan the QR code.



## PROPELLER USE

The Max-Prop EASY works automatically. By putting the transmission in gear the blades will engage in either forward or reverse (**WARNING: do not change from forward to reverse and vice versa when the engine is running at high RPM**) and feathers from forward position when you turn off the engine and lock the shaft.

The best way to feather the propeller is:

- Power at 2 to 3 knots in forward.
- Kill the engine while still engaged in forward.

If your propeller has been greased properly it will feather in a fraction of a second as soon as you stop the shaft from freewheeling. **DO NOT** kill the engine while in reverse. In this case the blades will be in the reverse position and cannot feather. You can actually use this feature to drive a shaft alternator, or regenerate with an electric motor.

Modern transmissions are either mechanical or hydraulic. With a mechanical transmission, the best way to stop the shaft freewheeling is to engage the transmission in reverse (**WARNING: engage the reverse only after the engine has stopped completely**). With a hydraulic transmission you must shut off the engine while still engaged in forward. The remaining hydraulic pressure will in effect lock the shaft for a few moments, enough for the Max-Prop to feather.

## MAINTENANCE

- The propeller must always be completely filled with recommended Lubrilate 130AA grease. The propeller should be greased at least once a year. This can be done with the boat in or out of the water.
- Make sure that you always keep the zinc anodes in good condition. They must be replaced at least once a year, even if they still look ok. The propeller must be protected by a lot of zinc, so also use a zinc on the shaft when possible. When replacing it make sure that you clean the surfaces between the zinc and the propeller shaft in order to have a good electrical contact.



## WARNING

It is important to follow the instruction below carefully so as to avoid a shock load to the gears on the blades and cone gear, that could be damaging to the teeth.

- When going from forward to reverse and the opposite, it is necessary to idle down and shift at low RPM's between gear, that could be damaging to the teeth.

## PROPELLER REMOVAL

In order to remove the propeller you must first remove the zinc and remove the nut. Next fit a long armed gear puller over the front of the propeller as shown in Fig.7 on page 8. Tightening the center bolt of the gear puller will release the Max-Prop from the propeller shaft.

If the bolt from the gear puller is not long enough to contact the end of the propeller shaft inside the Max-Prop nut can be loosened and left in place. In this scenario the bolt from the puller will push against the back of the nut to release the propeller from the shaft.

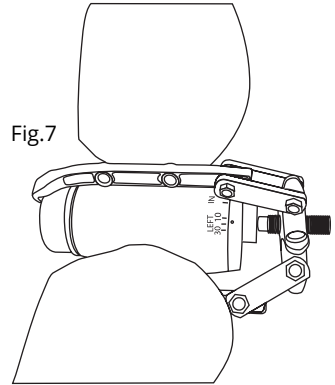

## PROPER FITTING OF A NEW LOCKING NUT OF THE PROPELLER

If the shaft nut needs to be replaced at any time during the life of the propeller, it will need to be fit to this propeller with the correct tolerances (may require some light machining). Of course, when receiving a new propeller, the nut has already been machined to fit with the proper tolerances.

1. When it's locked on the motor shaft, the nut must contact the 3 surfaces S1, S2, S3. Therefore, if a new nut has to be machined you must be sure that length L1 and L2 coincide precisely with the corresponding lengths of prop hub, and that length L3 is greater than the length of the threaded edge of motor shaft. To check that the work is done properly, you just have to spread a very thin coat of Prussian blue on the 3 surfaces S1, S2, S3. Insert the nut in its seat in the hub and let the nut rotate softly in relation to the hub, with a light pressure. When this is done, the 3 surfaces of the hub must be painted in blue.
2. When fitting the prop on the motor shaft, it's necessary to check that the threaded part of the motor shaft doesn't touch the threaded end of the nut. Also, when the nut is tight, the blades rotation on their axis does not get hard. In case the blades rotation movement becomes hard, you have to remove from surface S1 a very small amount of material. This operation can be done simply by using a flat smooth file.

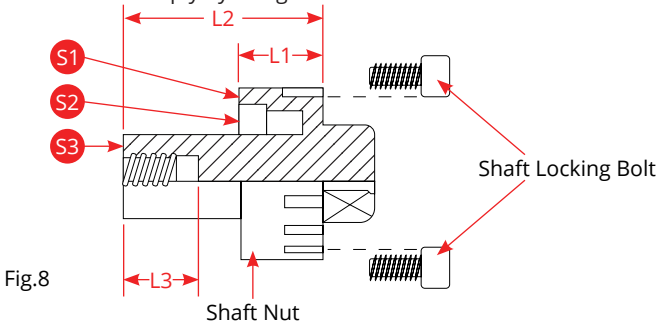





For installation videos  
visit our website.

**WWW.MAX-PROP.COM**

**U.S. HEADQUARTERS**

12532 Beverly Park Road  
Lynnwood, WA 98087  
(425) 355-3669  
info@pyiinc.com  
www.pyiinc.com

---

**EUROPEAN HEADQUARTERS**

ZI du Capitou, 85 rue Louis Lepine  
83600 Frejus - France  
+33 4 94 5327 70  
info@seaviewprogress.com  
www.seaviewprogress.com

---

**UK OFFICE**

+44 (0) 7393 556751  
simon.wood@seaviewprogress.co.uk  
www.seaviewprogress.com

Get social with us!



**YouTube**